

# *Flexible* MOULDINGS



S E L E C T I O N   G U I D E

Visit [www.flextrim.com](http://www.flextrim.com) for More Profiles

# CarterFlex

**FLEX TRIM™**

by CARTER MILLWORK

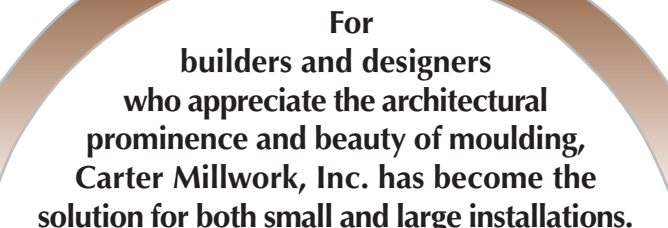

For  
builders and designers  
who appreciate the architectural  
prominence and beauty of moulding,  
Carter Millwork, Inc. has become the  
solution for both small and large installations.  
Whether the need is one uniquely designed  
style or hundreds of feet with optimum  
consistency, we satisfy the demand with quality  
assured mouldings. Each piece is individually  
inspected to provide the highest quality control.  
Here are features that make CarterFlex one  
of the most desired moulding products in  
the building industry.

- **MATERIALS**  
Polyurethane Composite Material
- **WARRANTY**  
Lifetime warranty for products
- **MOULDING SIZES**  
Same sizes as wood
- **FLEXIBILITY**  
6 standard sizes cover 1/8 to 7/0 Half Round
- **FINISHING**  
Accepts paint or stain
- **MACHINING**  
Use same tools as wood
- **STRENGTH**  
Heat - Minimal Effect  
Cold - Minimal Effect
- **VALUE**  
Low cost with excellent performance

We are available to provide any ordering information or answer any questions Monday through Friday. You may order by calling 1-800-861-0734 or sending faxes to 1-800-861-0737.

We ship all orders Prepaid and delivery of Stock Items is made within one or two days for UPS shipments. We schedule regular deliveries with common carriers for larger orders.

2

Carter Millwork has maintained a leadership role by helping artisans create their vision through moulding replications.

Our Made-To-Match process (**MTM**), gives Carter Millwork the unique opportunity to match any style our customers wish to replicate. Through this process, our skills and technology allow us to reproduce the most intricate and minimal moulding designs provided for replication.

By working with our skilled order specialists, we can fashion radius pieces to match your original samples. Typically, we create 12 ft. molds of the samples that you send. We replicate the moulding to fit your templates and specifications. We can ship both straight and curved mouldings to fit your project needs.

Because we give each order special attention, we have a reputation of exceeding industry delivery standards. We stock many profiles so that we can provide accelerated delivery. Many of these items are marked with an "S" in this guide; however, we have many more designs that may fit your ideas. We can search our inventory of mouldings using a small moulding piece or your tracing as reference. No order is too large or too small. Call us.



1-800-861-0734

# Ordering Information

We are always happy to help you with any specification questions before you enter your order.

These are some commonly requested configurations and typical information we need for production.

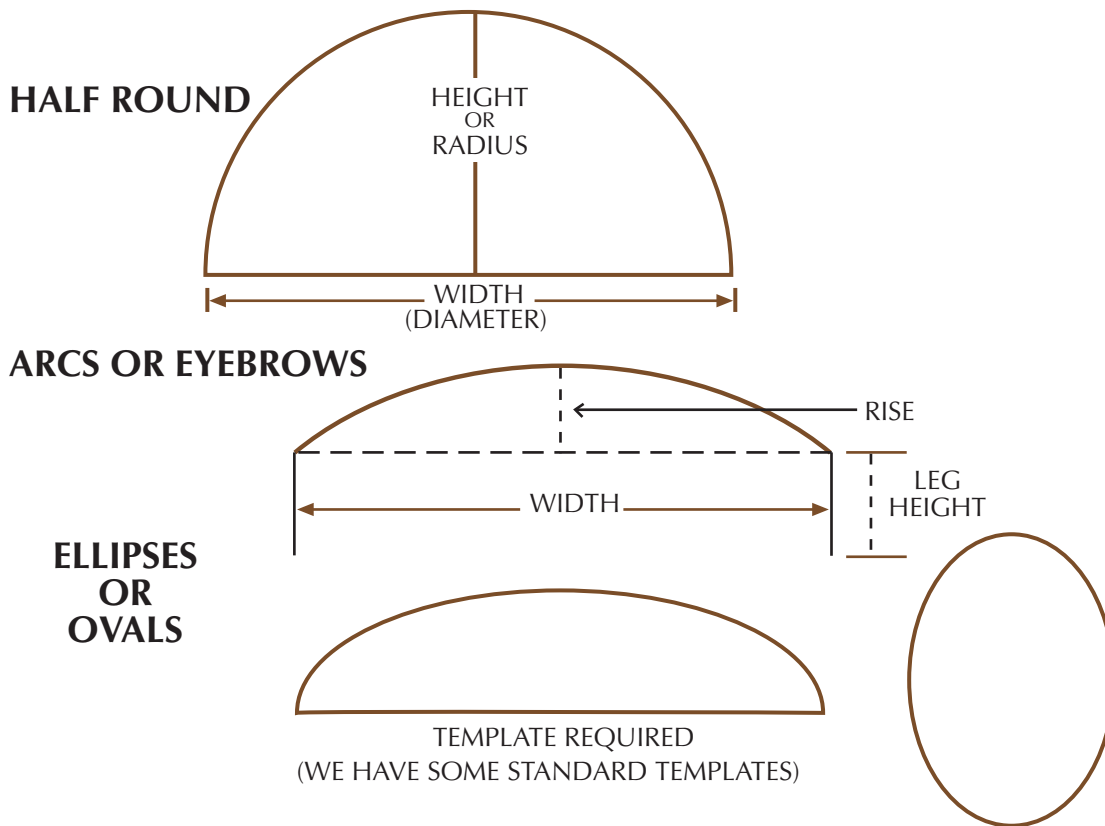

## RADIUS CROWN MOULDINGS



Please provide a radius dimension of wall or width of unit and how much the wall or ceiling recesses (ISR) or projects (OSR).

**NOTE:** Curved ceilings or dormers (Barrel Vaults) are convex or OSR applications. Please specify at time of order.

**IMPORTANT:** Straight (lineal, non pre-radiused) pieces will only be suitable for certain applications. Please call us with any information to insure appropriate material is ordered and provided.



The drawings shown in this book are a reference and may be different than actual mouldings produced.

Installation and care instructions for **CarterFlex** on page 4.

"S" items are in stock

# FLEX TRIM™

## INSTALLATION

### USE:

This flexible moulding is designed for interior and exterior use. This product is stable and will not absorb moisture. However, the use of a paint or gel stain and sealer is recommended for all applications.

### MACHINING

Conventional woodworking tools can be used with this material. Material can be cut, sanded and shaped with ease. Miter saws work well when trimming this material. As with all types of trim material, use care when marking and cutting.

### FASTENING

Always install moulding material in a relaxed position. Use construction or panel adhesive or mastic type glue continuously on back side and nails to secure moulding material in place until adhesive bonds.

- DO NOT use staples to fasten material.
- Keep nails to a minimum, no closer than 6" between nails.
- Do not nail closer than 3/8" from edge of moulding.

### CLEANING

Prior to finishing, clean the moulding by wiping with a cloth using soap and water, paint thinner or any mild solvent to clean any dirt or grease that may have accumulated during installation.

### PAINT & STAINING

All CARTERFLEX material is paint grade and most profiles have grain and can be stained. Inspect for grain or call for information on compatibility of staining. Staining of CARTERFLEX material requires the use of a gel type stain.

## LIFETIME WARRANTY

Carter Millwork, Inc. warrants that for the "lifetime" ownership, the CARTERFLEX moulding is free from defects in material and workmanship. "Lifetime" means as long as the original purchaser owns the structure to which the CARTERFLEX moulding has been properly attached. Carter Millwork, Inc. will repair or replace at its option any CARTERFLEX moulding that has failed as a result of defective material and workmanship. This remedy is the purchaser's exclusive remedy for breach of warranty hereunder.

THE FOREGOING WARRANTY IS IN LIEU OF ALL OTHER WARRANTIES, EXPRESS OR IMPLIED, INCLUDING BUT NOT LIMITED TO THE IMPLIED WARRANTIES OF MERCHANTABILITY AND FITNESS FOR A PARTICULAR PURPOSE.

At no time will Carter Millwork, Inc. be liable for more than the original purchase price of the moulding, nor will Carter Millwork, Inc. be liable for any special, incidental or consequential damages based upon breach of warranty, breach of contract, loss of profits, loss of savings or revenue, loss of use, the claims of third parties and injury to property. Some states do not allow limits on warranties or on remedies for breach in certain transactions. In such states, the limits in this paragraph and the preceding paragraph may not apply.

It shall remain the responsibility of the customer to insure that the moulding purchased is designed for their particular installation.

**TO AVOID DAMAGE DO NOT NAIL CLOSER THAN 3/8 IN. FROM EDGE**

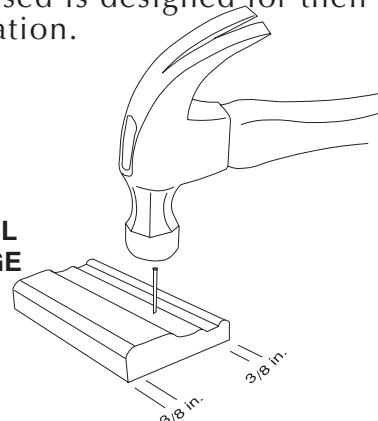

# CASINGS



Many more profiles available, call... 1-800-861-0734 • FAX 1-800-861-0737

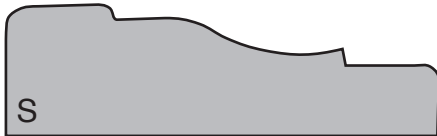

S

CM356 (WM356)  
1<sup>1</sup>/<sub>16</sub> X 2<sup>1</sup>/<sub>4</sub> in.

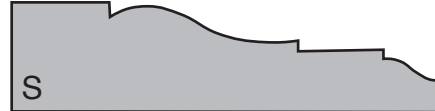

S

CM366 (WM366)  
1<sup>1</sup>/<sub>16</sub> X 2<sup>1</sup>/<sub>4</sub> in.

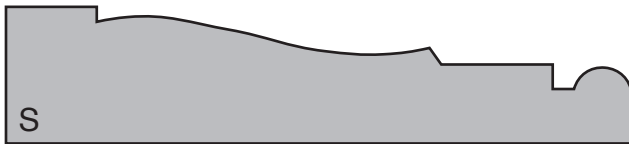

S

CM445 (WM445)  
1<sup>1</sup>/<sub>16</sub> X 3<sup>1</sup>/<sub>4</sub> in.

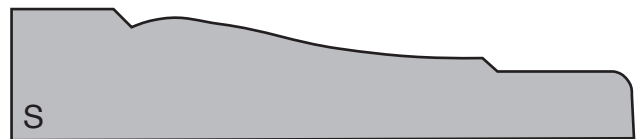

S

CM444 (EC444)  
1<sup>1</sup>/<sub>16</sub> X 3<sup>1</sup>/<sub>4</sub> in.

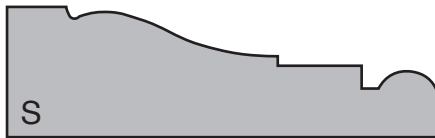

S

CM376 (WM376)  
1<sup>1</sup>/<sub>16</sub> X 2<sup>1</sup>/<sub>4</sub> in.



CM444A (WM444)  
1<sup>1</sup>/<sub>16</sub> X 3<sup>1</sup>/<sub>2</sub> in.

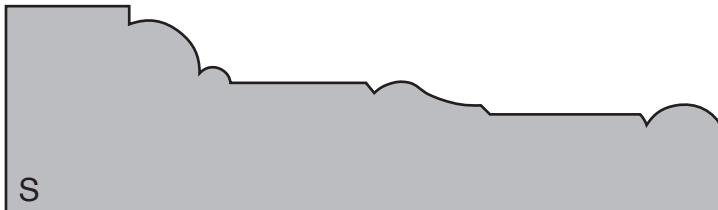

S

CM470 (EC470)  
1<sup>1</sup>/<sub>16</sub> X 3<sup>11</sup>/<sub>16</sub> in.

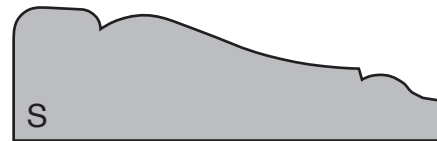

S

CM442 (EC442)  
1<sup>1</sup>/<sub>16</sub> X 2<sup>1</sup>/<sub>4</sub> in.

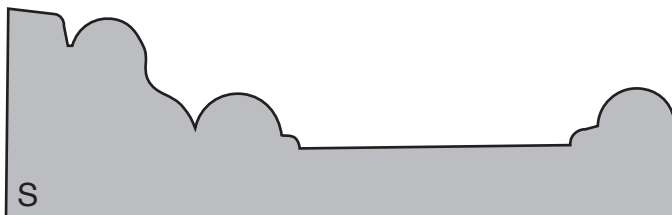

S

CM1 (EC001)  
1<sup>1</sup>/<sub>16</sub> X 3<sup>1</sup>/<sub>2</sub> in.

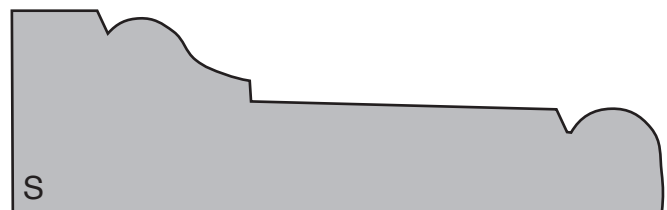

S

CM97 (EC020)  
1<sup>1</sup>/<sub>16</sub> X 3<sup>1</sup>/<sub>2</sub> in.

# CASINGS



1-800-861-0734 • FAX 1-800-861-0737

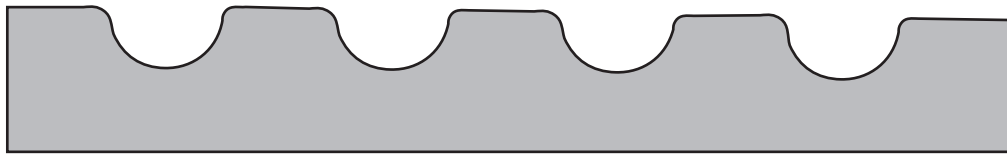

CNF525  
3/4 X 5 1/4 in.

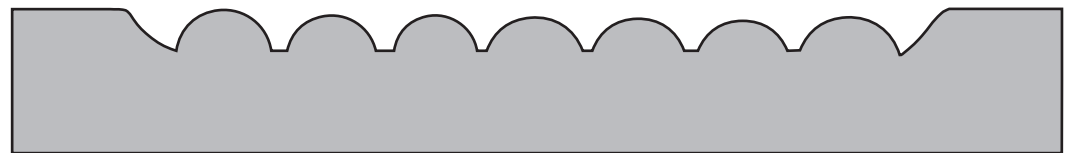

C606R  
1 1/16 X 5 1/2 in.



SM75  
3/4 X 5 1/2 in.



SM85  
3/4 X 5 1/4 in.



C606F  
1 1/16 X 5 1/2 in.



SM5806  
3/4 X 5 1/2 in.

# CASINGS



Many more profiles available, call...1-800-861-0734 • FAX 1-800-861-0737

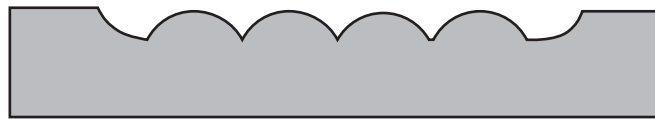

C600R  
1<sup>1</sup>/<sub>16</sub> X 3<sup>1</sup>/<sub>2</sub> in.



CM14R (EC14R)  
1<sup>1</sup>/<sub>16</sub> X 3<sup>1</sup>/<sub>4</sub> in.

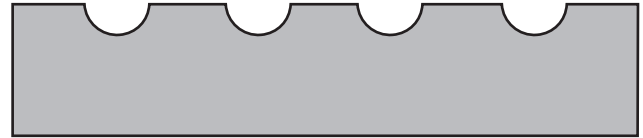

CM14F (EC14F)  
1<sup>1</sup>/<sub>16</sub> X 3<sup>1</sup>/<sub>4</sub> in.



PT338F  
5/8 X 3<sup>3</sup>/<sub>8</sub> in.



PT338R  
5/8 X 3<sup>3</sup>/<sub>8</sub> in.



CCC350  
3/4 X 3<sup>7</sup>/<sub>16</sub> in.



1002  
9/16 X 3<sup>9</sup>/<sub>16</sub> in.



1002M  
1/2 X 2<sup>1</sup>/<sub>4</sub> in.



CNF312  
3/4 X 3<sup>7</sup>/<sub>16</sub> in.



SM8  
3/4 X 5 in.

# CASINGS



1-800-861-0734 • FAX 1-800-861-0737



SM12  
1<sup>5</sup>/<sub>16</sub> X 4<sup>1</sup>/<sub>2</sub> in.

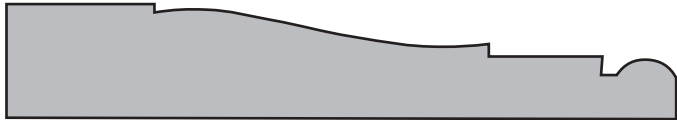

CM445A  
1<sup>1</sup>/<sub>16</sub> X 3<sup>1</sup>/<sub>2</sub> in.

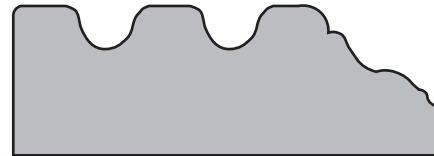

CFC 214, <sup>3</sup>/<sub>4</sub> X 2<sup>1</sup>/<sub>4</sub> in.  
Also Available:  
CFC 315, <sup>3</sup>/<sub>4</sub> X 3<sup>1</sup>/<sub>2</sub> in.  
CFC 425, <sup>3</sup>/<sub>4</sub> X 4<sup>1</sup>/<sub>4</sub> in.

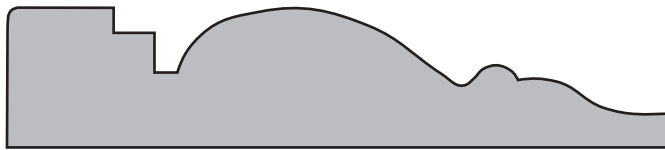

24112 PCA  
<sup>3</sup>/<sub>4</sub> X 3<sup>1</sup>/<sub>2</sub> in.



2814  
1<sup>1</sup>/<sub>4</sub> X 4<sup>5</sup>/<sub>8</sub> in.

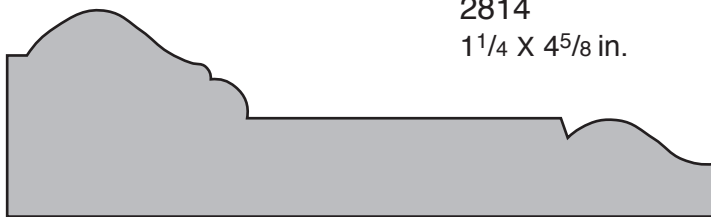

CM460  
1<sup>1</sup>/<sub>16</sub> X 3<sup>11</sup>/<sub>16</sub> in.



CM371 (RB371)  
1<sup>1</sup>/<sub>16</sub> X 3 in.

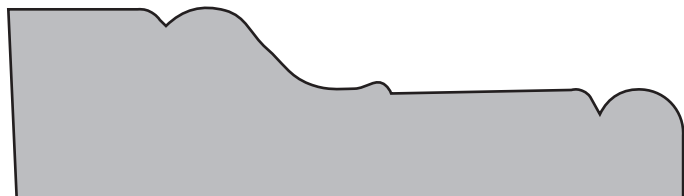

MD2  
1 X 3<sup>1</sup>/<sub>2</sub> in.



NH234  
<sup>7</sup>/<sub>8</sub> X 2<sup>3</sup>/<sub>4</sub> in.



# CASINGS



Many more profiles available, call...1-800-861-0734 • FAX 1-800-861-0737

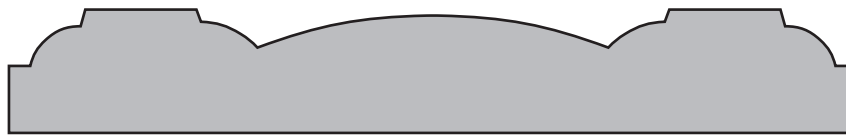

SM7  
1<sup>1</sup>/<sub>16</sub> X 4<sup>1</sup>/<sub>2</sub> in.

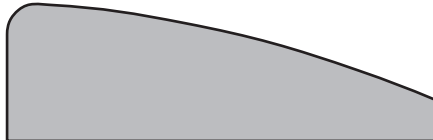

CM327 (WM327)  
1<sup>1</sup>/<sub>16</sub> X 2<sup>1</sup>/<sub>4</sub> in.

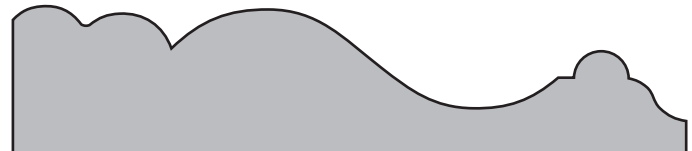

CKR350  
3/4 X 3<sup>1</sup>/<sub>2</sub> in.

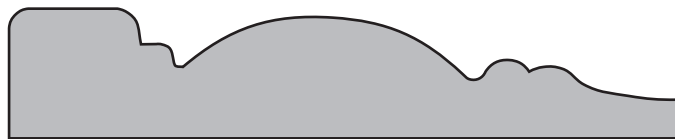

PM719  
1<sup>1</sup>/<sub>16</sub> X 3<sup>1</sup>/<sub>2</sub> in.



CBG275  
3/4 X 2<sup>3</sup>/<sub>4</sub> in.

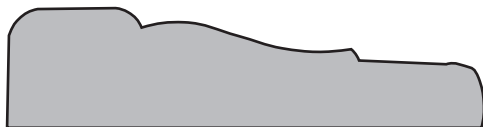

WM351 (CM351)  
1<sup>1</sup>/<sub>16</sub> X 2<sup>1</sup>/<sub>2</sub> in.



RIDOUT 376  
1 in. X 3 in.

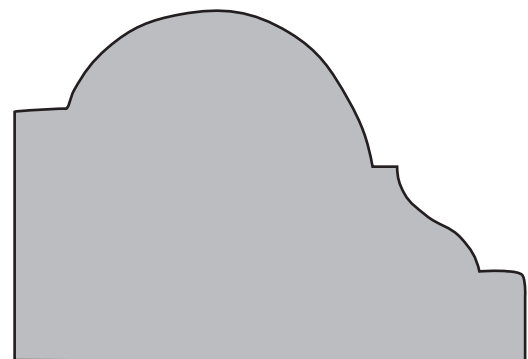

CAS50  
1<sup>3</sup>/<sub>4</sub> X 2<sup>1</sup>/<sub>2</sub> in.



CKN425  
3/4 X 4<sup>1</sup>/<sub>4</sub> in.

# CASINGS



1-800-861-0734 • FAX 1-800-861-0737

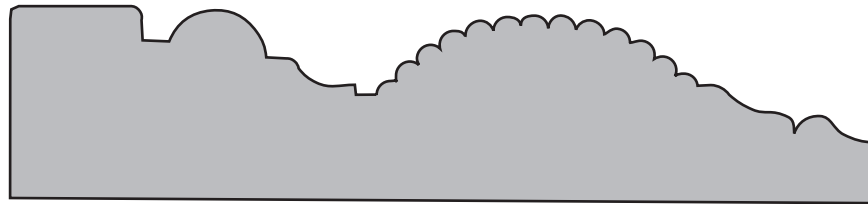

LSM2060  
1<sup>1</sup>/<sub>16</sub> X 4<sup>1</sup>/<sub>2</sub> in.

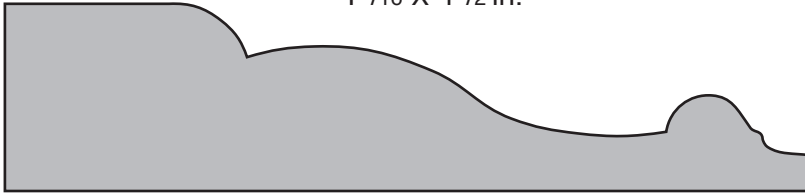

BM1188  
1 X 4<sup>1</sup>/<sub>4</sub> in.

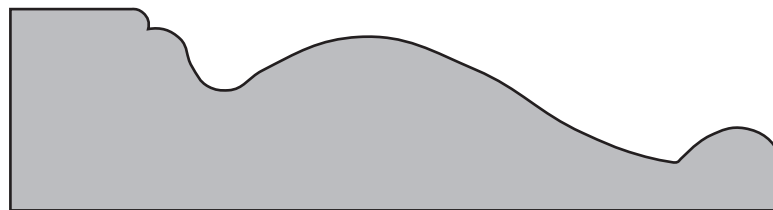

CN400  
1 X 4 in.

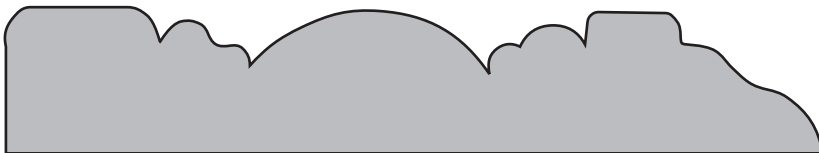

CBG400  
3/4 X 4<sup>1</sup>/<sub>4</sub> in.



CRC350  
3/4 X 3<sup>1</sup>/<sub>2</sub> in.



CRC425  
3/4 X 4<sup>1</sup>/<sub>2</sub> in.

# CASINGS



Many more profiles available, call...1-800-861-0734 • FAX 1-800-861-0737



CGA425  
1 X 4<sup>1</sup>/<sub>4</sub> in.

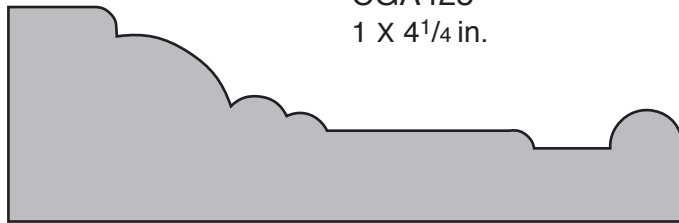

COXCOMB  
1<sup>1</sup>/<sub>16</sub> X 3<sup>1</sup>/<sub>2</sub> in.

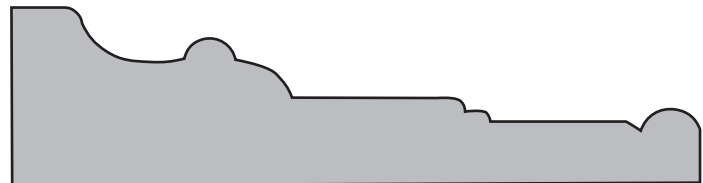

NH358  
7/8 X 3<sup>5</sup>/<sub>8</sub> in.

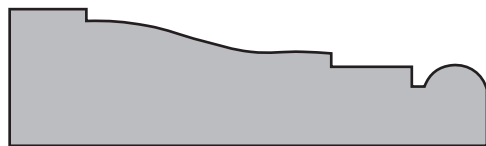

WM371  
1<sup>1</sup>/<sub>16</sub> X 2<sup>1</sup>/<sub>2</sub> in.

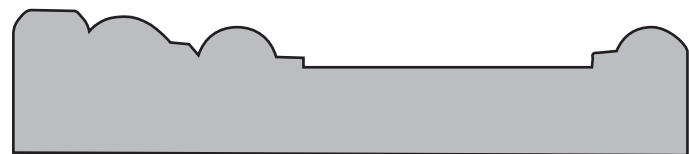

CKN350  
3/4 X 3<sup>1</sup>/<sub>2</sub> in.

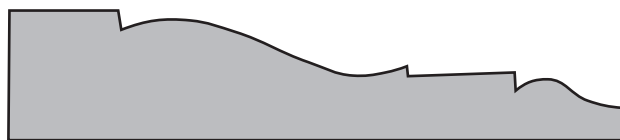

CM361 (EC361)  
1<sup>1</sup>/<sub>16</sub> X 3<sup>1</sup>/<sub>4</sub> in.



SM83  
3/4 X 4<sup>1</sup>/<sub>8</sub> in.

# CASINGS



1-800-861-0734 • FAX 1-800-861-0737

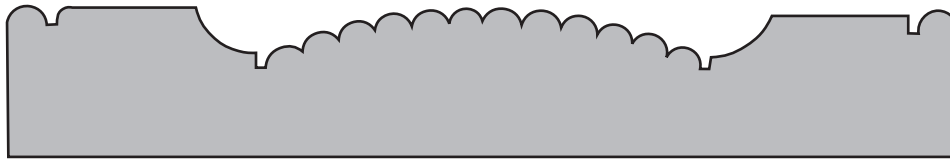

SM80  
3/4 X 5 in.

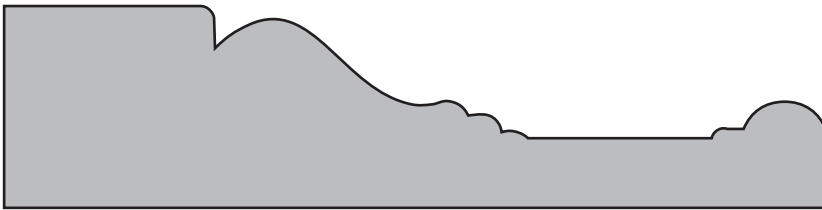

CJF425  
1 X 4 1/4 in.



LWM 97  
3/4 X 3 1/2 in.

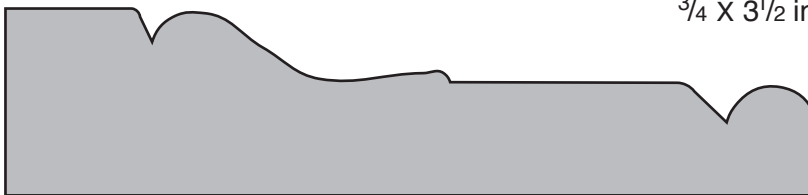

C425  
1 X 4 1/4 in.

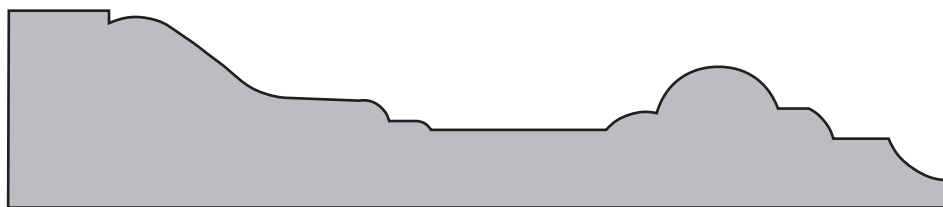

MISS JENNY  
1 1/16 X 4 7/8 in.

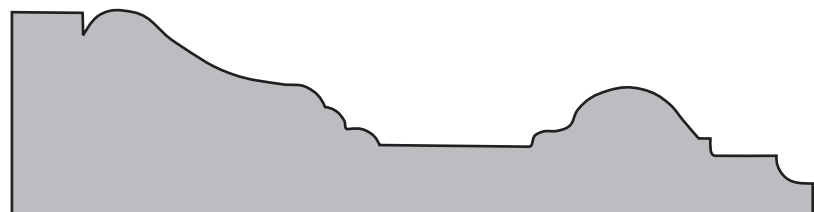

CAG425  
1 1/16 X 4 1/4 in.

# CASINGS



Many more profiles available, call...1-800-861-0734 • FAX 1-800-861-0737



CM433 (WM433)  
9/16 X 3 1/4 in.



CM473 (WM473)  
9/16 X 2 1/4 in.

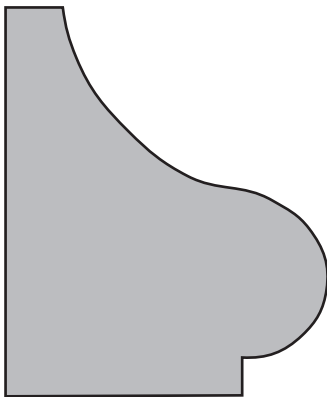

CAS30  
1 3/4 X 2 in.



CM452 (WM452)  
1 1/16 X 2 1/2 in.



SM2050  
1 1/16 X 4 1/2 in.

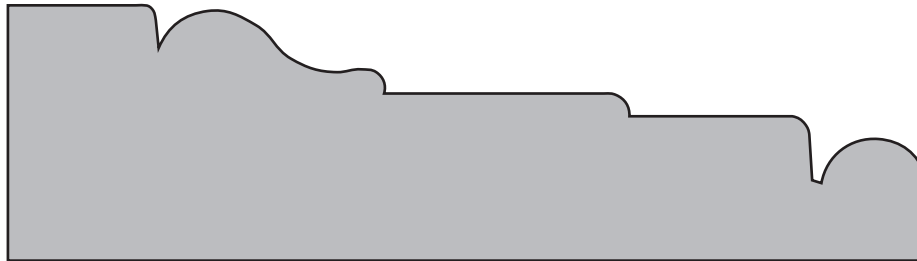

BM995  
1 5/16 X 4 3/4 in.

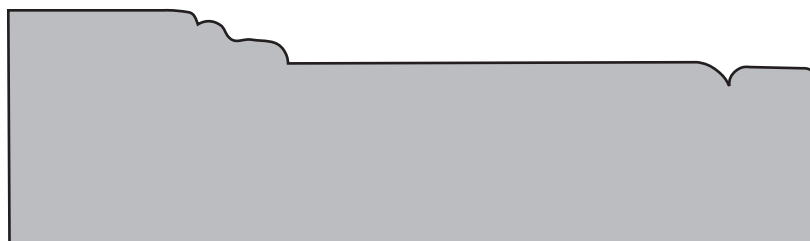

SM 5701  
1 1/4 X 4 1/2 in.

# CASINGS



1-800-861-0734 • FAX 1-800-861-0737

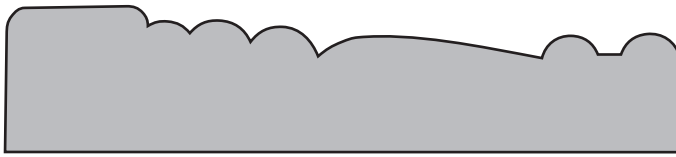

CAM350  
 $\frac{3}{4}$  X  $3\frac{1}{2}$  in.

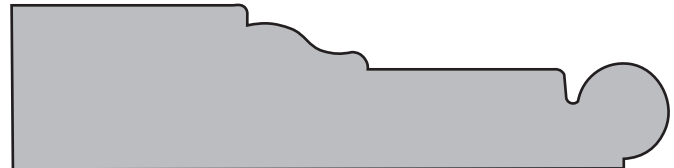

BM1455  
 $\frac{7}{8}$  X  $4\frac{3}{32}$  in.

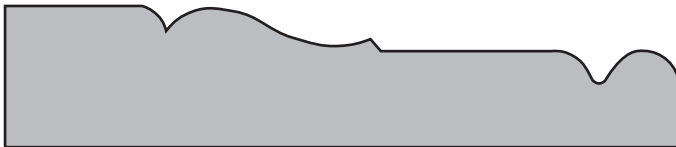

C352  
 $\frac{3}{4}$  X  $3\frac{1}{2}$  in.

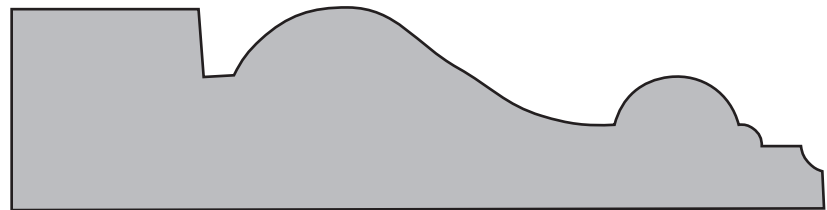

RBI SPR3  
 $1\frac{1}{16}$  X  $4\frac{1}{4}$  in.



BM255  
 $1\frac{3}{16}$  X  $3\frac{15}{16}$  in.



CAM400  
 $\frac{3}{4}$  X  $4\frac{1}{4}$  in.

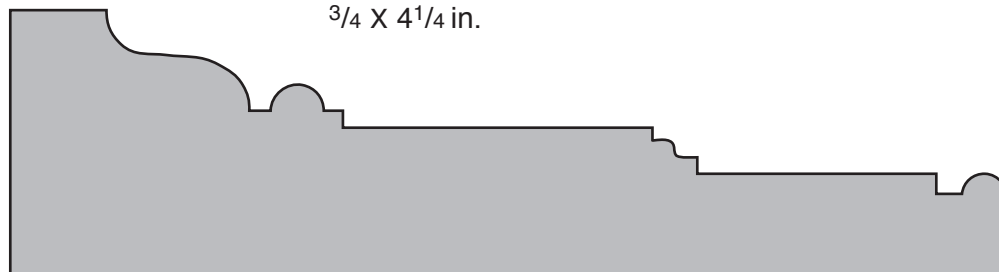

SM84  
 $1\frac{3}{8}$  X  $5\frac{1}{4}$  in.

# CASINGS



Many more profiles available, call...1-800-861-0734 • FAX 1-800-861-0737

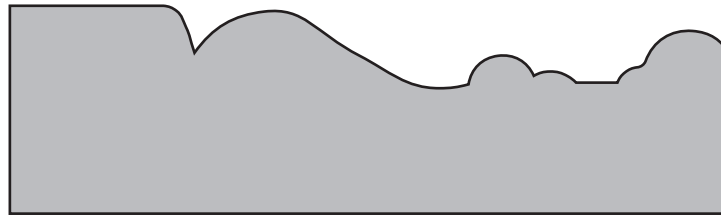

RBI208  
1<sup>1</sup>/<sub>16</sub> X 3<sup>3</sup>/<sub>4</sub> in.



CTE350  
3/4 X 3<sup>1</sup>/<sub>2</sub> in.



CM683 (WM683)  
1<sup>1</sup>/<sub>16</sub> X 3<sup>1</sup>/<sub>4</sub> in.



TM1  
1<sup>1</sup>/<sub>16</sub> X 3<sup>1</sup>/<sub>4</sub> in.

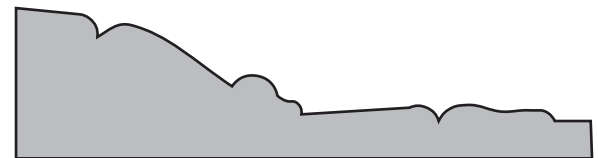

399  
3/4 X 3 in.

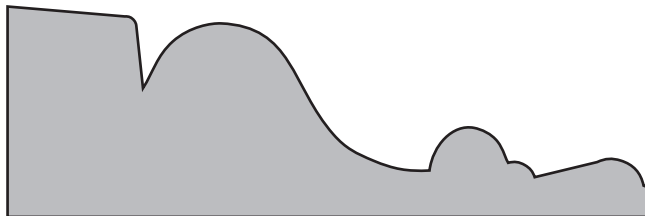

MS1661 SPROT LONG  
1<sup>1</sup>/<sub>8</sub> X 3<sup>3</sup>/<sub>8</sub> in.

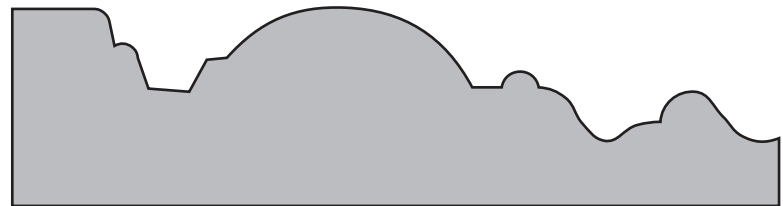

SM2051  
1 X 4 in.

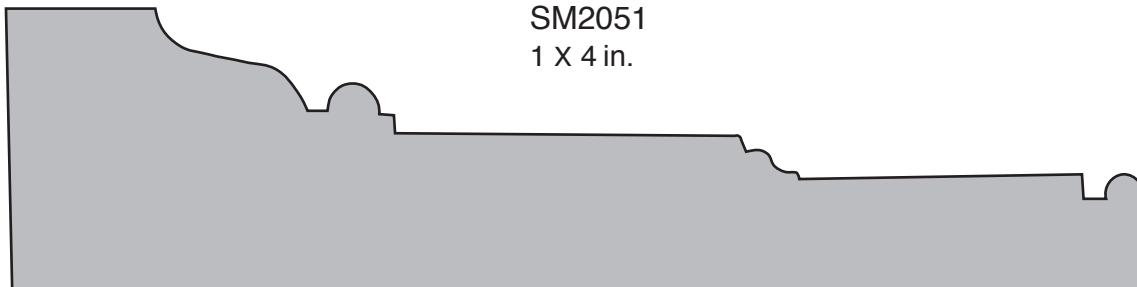

CW1 Also available: 1<sup>7</sup>/<sub>16</sub> X 4 in.  
1<sup>7</sup>/<sub>16</sub> X 5<sup>5</sup>/<sub>8</sub> in.

# CASINGS



1-800-861-0734 • FAX 1-800-861-0737

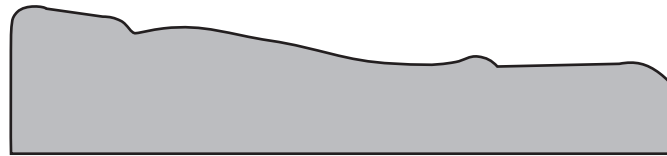

C351  
 $\frac{3}{4}$  X  $3\frac{1}{2}$  in.



LW444  
 $1\frac{1}{16}$  X  $3\frac{1}{4}$  in.



LDFCA4  
1X 4 in.



CKN234  
 $\frac{3}{4}$  X  $2\frac{3}{4}$  in.



SM82  
 $1\frac{1}{16}$  X  $2\frac{3}{4}$  in.

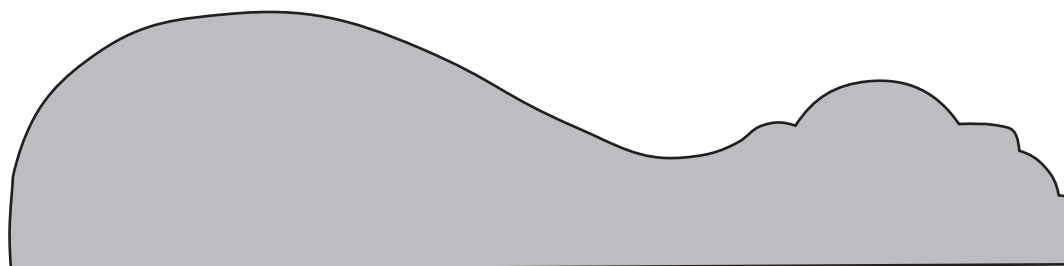

EC490  
 $1\frac{5}{16}$  X  $5\frac{1}{2}$  in.



# CASINGS



*Many more profiles available, call...1-800-861-0734 • FAX 1-800-861-0737*

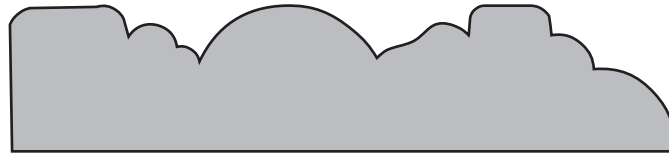

CBG300  
3/4 X 3 1/2 in.

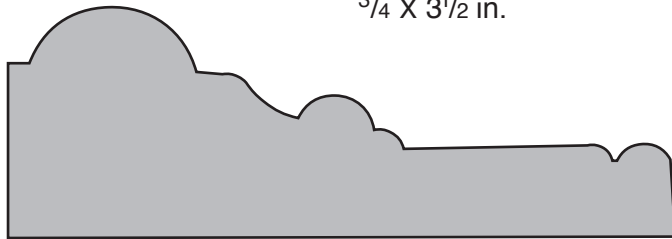

SM47  
1 1/4 X 3 1/2 in



PT312  
5/8 X 3 in.

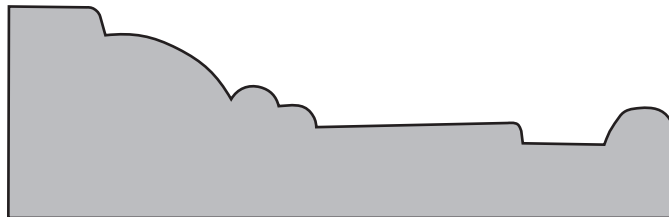

SM2  
1 1/16 X 3 5/8 in.

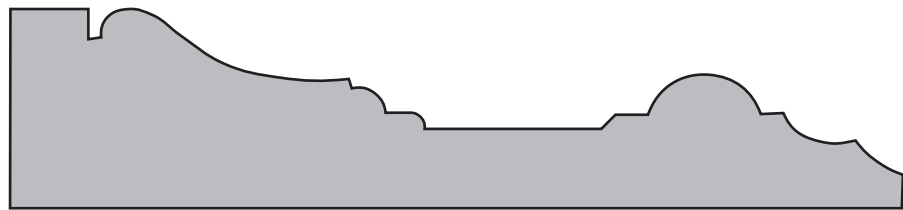

CM466 (EC466)  
1 1/16 X 4 5/8 in.

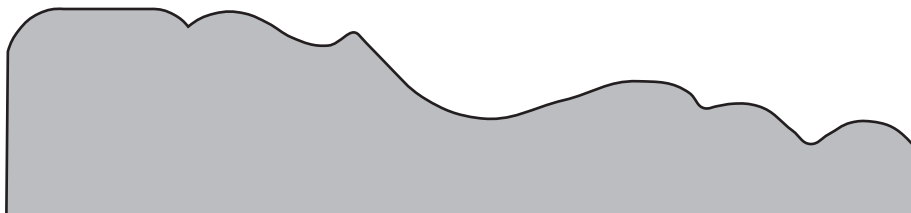

PRESIDENTIAL  
1 1/16 X 4 3/4 in.

# CASINGS



1-800-861-0734 • FAX 1-800-861-0737

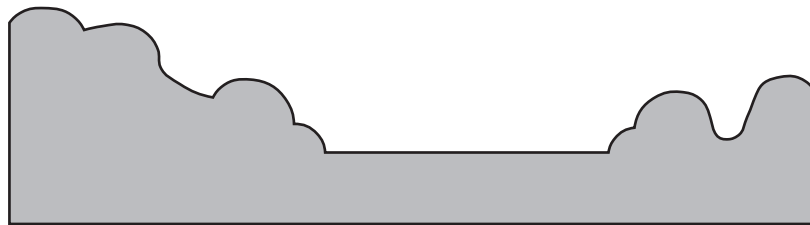

34136-CA  
1<sup>1</sup>/<sub>8</sub> X 4<sup>1</sup>/<sub>4</sub> in.



TMMH (Mini Howe)  
1<sup>1</sup>/<sub>16</sub> X 2<sup>3</sup>/<sub>4</sub> in.

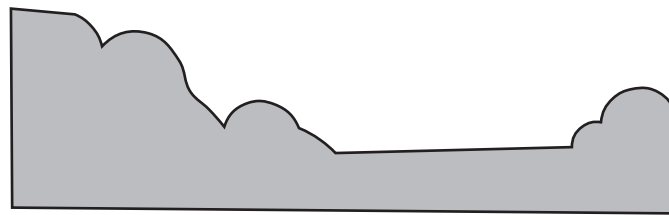

DELTA HOWE  
1 X 3<sup>7</sup>/<sub>16</sub> in.

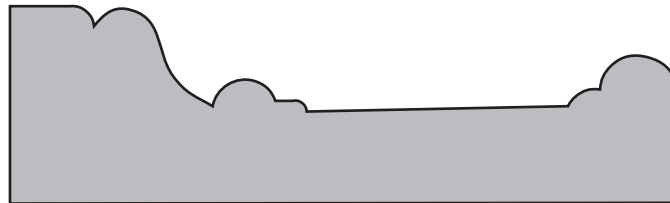

CKN535  
1 X 3<sup>1</sup>/<sub>2</sub> in.

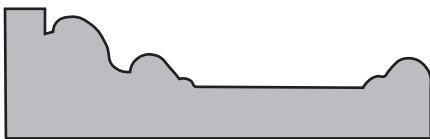

CM10  
1<sup>1</sup>/<sub>16</sub> X 2<sup>3</sup>/<sub>8</sub> in.

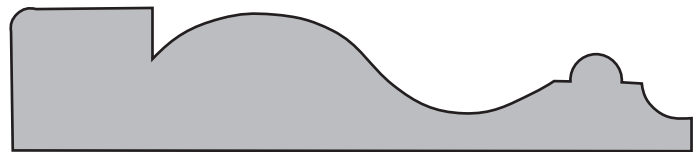

CVA350  
3/4 X 3<sup>1</sup>/<sub>2</sub> in.

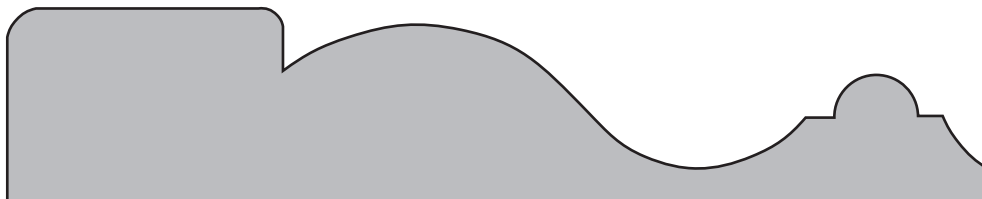

CVA525  
1 X 5<sup>1</sup>/<sub>4</sub> in.



MSI1  
1<sup>1</sup>/<sub>16</sub> X 3<sup>1</sup>/<sub>4</sub> in.

# BACK BANDS



Many more profiles available, call...1-800-861-0734 • FAX 1-800-861-0737

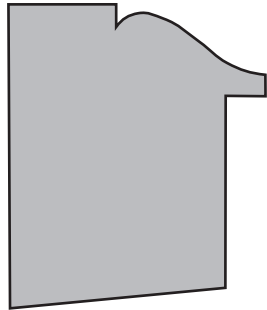

**C282**  
1<sup>5</sup>/<sub>16</sub> X 1<sup>5</sup>/<sub>8</sub> in.

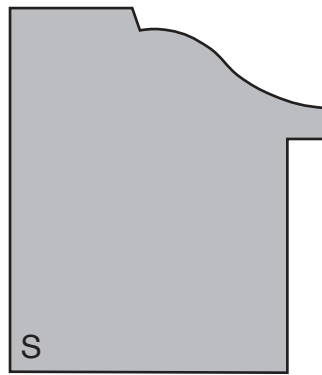

**CM809**  
1<sup>3</sup>/<sub>8</sub> X 1<sup>5</sup>/<sub>8</sub> in.

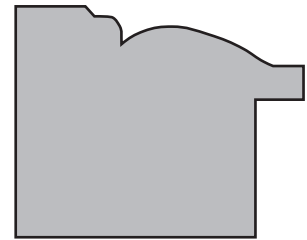

**4046USBB**  
1<sup>3</sup>/<sub>16</sub> X 1<sup>1</sup>/<sub>2</sub> in.

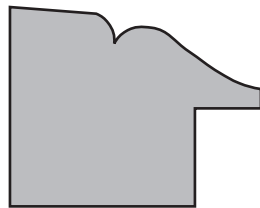

**97BB**  
1<sup>1</sup>/<sub>8</sub> X 1<sup>1</sup>/<sub>16</sub> in.

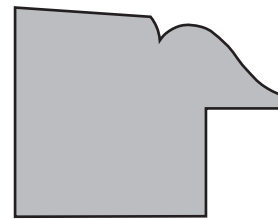

**SM68**  
1<sup>1</sup>/<sub>16</sub> X 1<sup>7</sup>/<sub>16</sub> in.

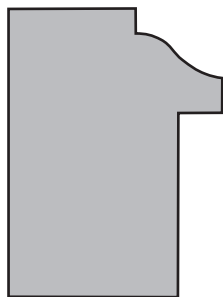

**BR285**  
1<sup>1</sup>/<sub>8</sub> X 1<sup>1</sup>/<sub>2</sub> in.

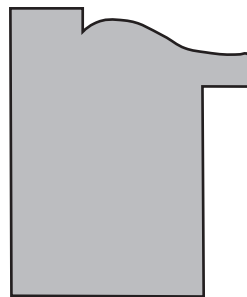

**4048US-BB**  
1<sup>1</sup>/<sub>4</sub> X 1<sup>1</sup>/<sub>2</sub> in.

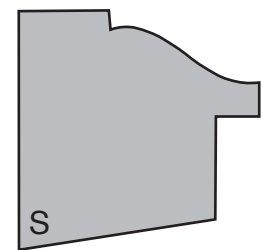

**C281**  
1<sup>5</sup>/<sub>16</sub> X 1<sup>5</sup>/<sub>16</sub> in.

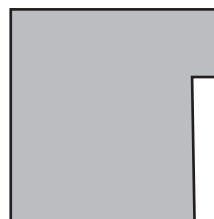

**3436BB**  
1<sup>1</sup>/<sub>16</sub> X 1<sup>1</sup>/<sub>8</sub> in.

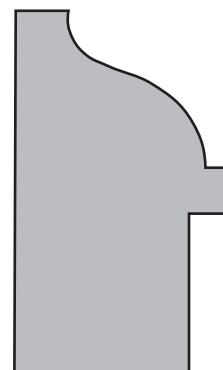

**SM2513**  
1<sup>1</sup>/<sub>8</sub> X 1<sup>7</sup>/<sub>8</sub> in.

# BACK BANDS



1-800-861-0734 • FAX 1-800-861-0737



SM2501-2  
1<sup>9</sup>/<sub>16</sub> X 2<sup>1</sup>/<sub>8</sub> in.



BB200  
1<sup>1</sup>/<sub>2</sub> X 2<sup>3</sup>/<sub>8</sub> in.

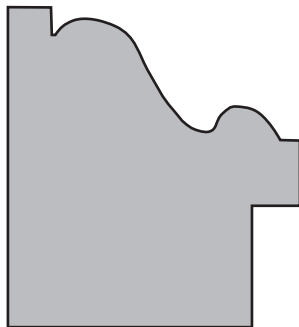

SM2501  
1<sup>9</sup>/<sub>16</sub> X 1<sup>11</sup>/<sub>16</sub> in.

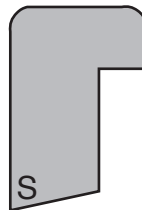

CM280 (WM280)  
1<sup>1</sup>/<sub>16</sub> X 1<sup>1</sup>/<sub>16</sub> in.

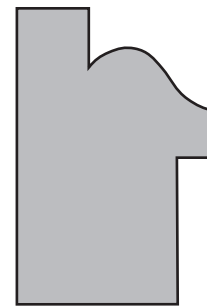

SM2510  
1<sup>1</sup>/<sub>16</sub> X 1<sup>1</sup>/<sub>2</sub> in.

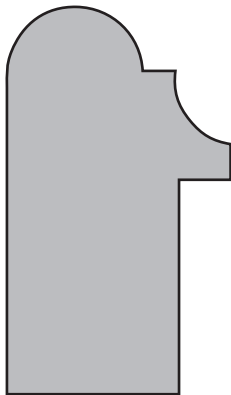

SM2511-2  
1<sup>3</sup>/<sub>16</sub> X 2 in.

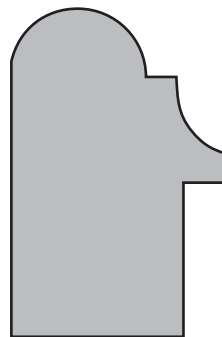

SM2511  
1<sup>3</sup>/<sub>16</sub> X 1<sup>3</sup>/<sub>4</sub> in.

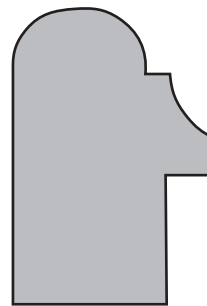

CM289  
1<sup>1</sup>/<sub>16</sub> X 1<sup>9</sup>/<sub>16</sub> in.

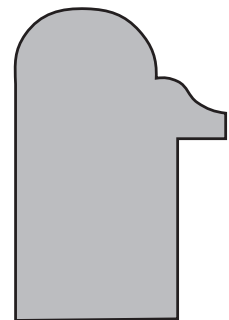

CRC150  
1 X 1<sup>5</sup>/<sub>8</sub> in.  
Also Available:  
5/8 Rabbett  
1<sup>1</sup>/<sub>16</sub> Rabbett

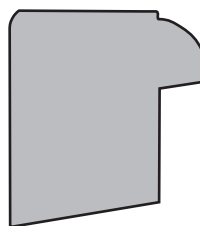

GP281  
1 X 1<sup>1</sup>/<sub>8</sub> in.

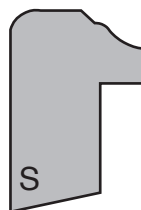

CM281 (WM281)  
1<sup>1</sup>/<sub>16</sub> X 1<sup>1</sup>/<sub>8</sub> in.

# CROWN



Many more profiles available, call...1-800-861-0734 • FAX 1-800-861-0737

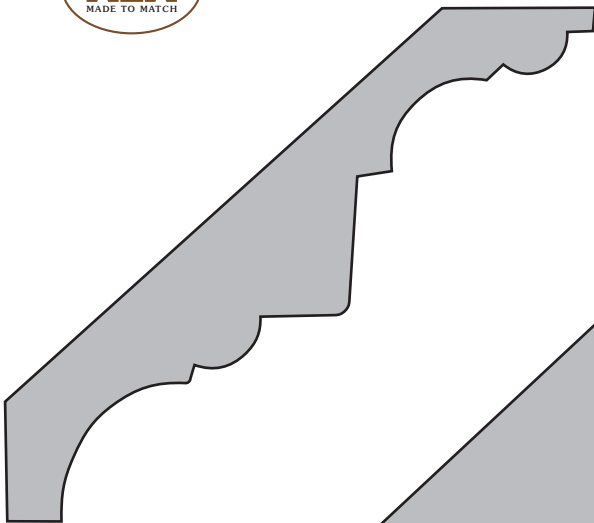

SM27  
7/8 X 4 1/8 in.

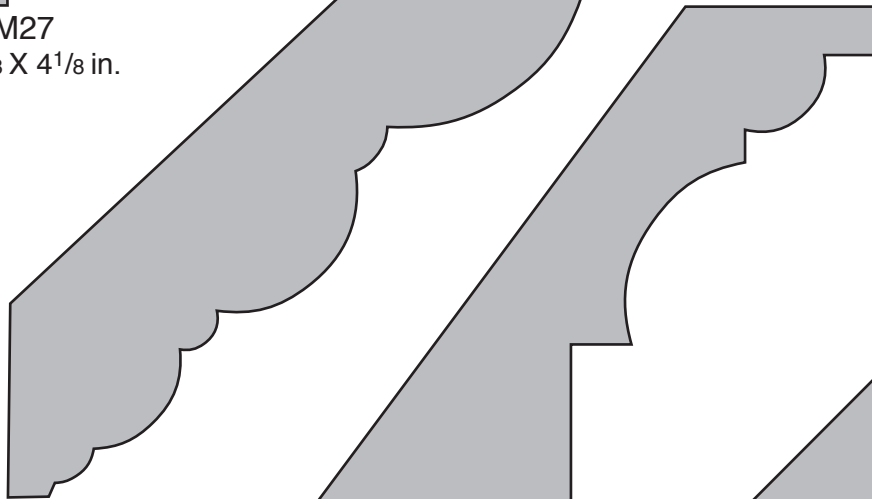

SM603  
1 X 7 1/4 in.

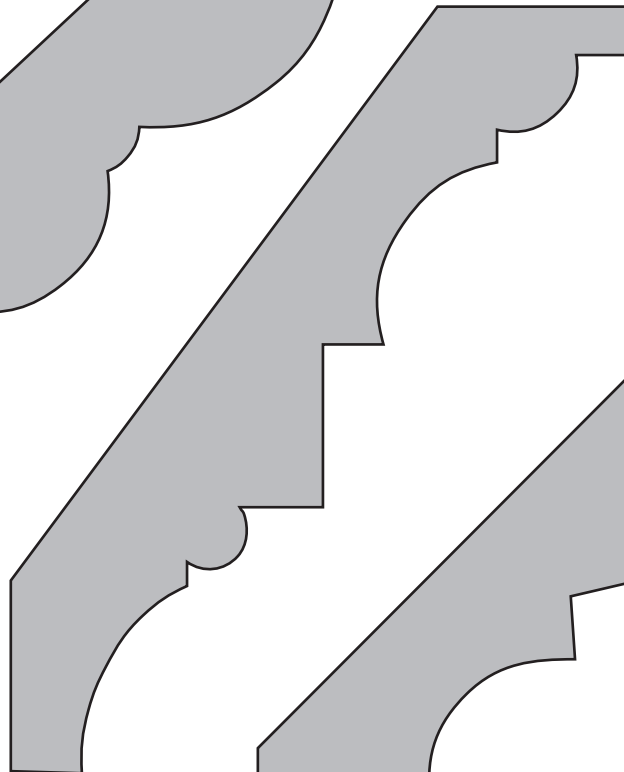

SM29  
1 11/16 X 5 1/8 in.

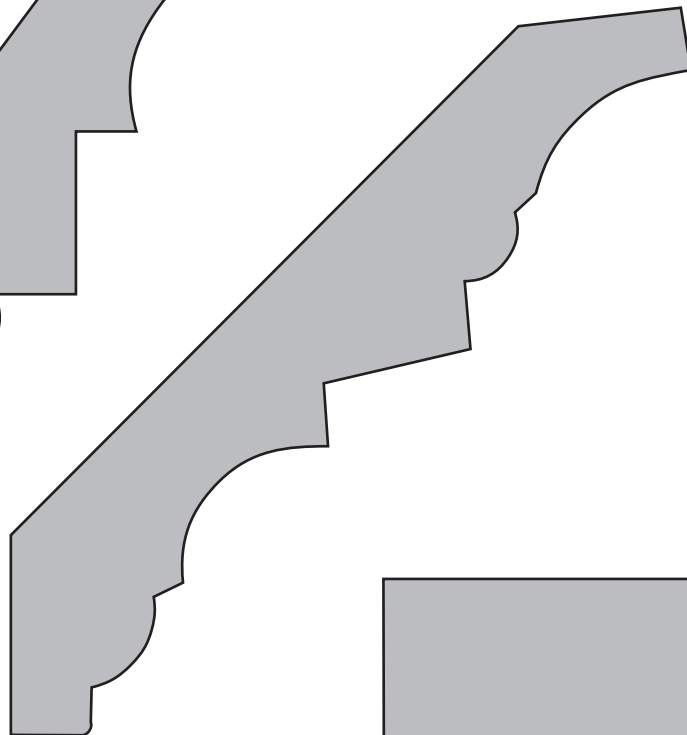

BM6  
1 X 6 3/4 in.

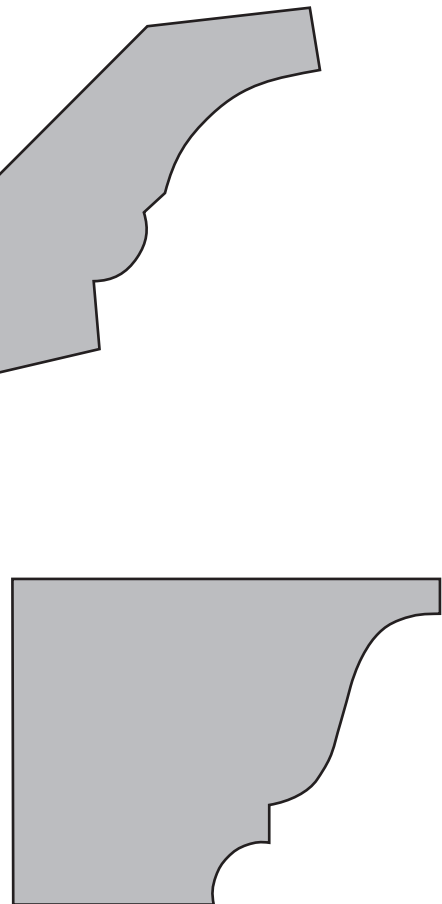

SM42  
2 1/4 X 1 5/8 in.

# CROWN



1-800-861-0734 • FAX 1-800-861-0737

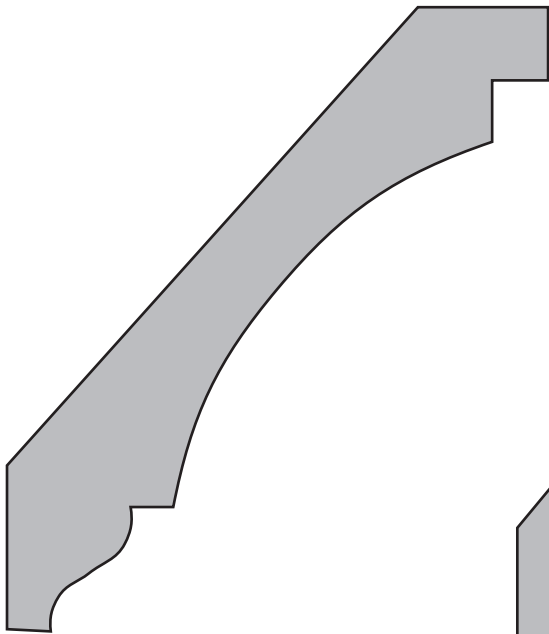

AH40  
1<sup>1</sup>/<sub>16</sub> X 4<sup>1</sup>/<sub>4</sub> in.

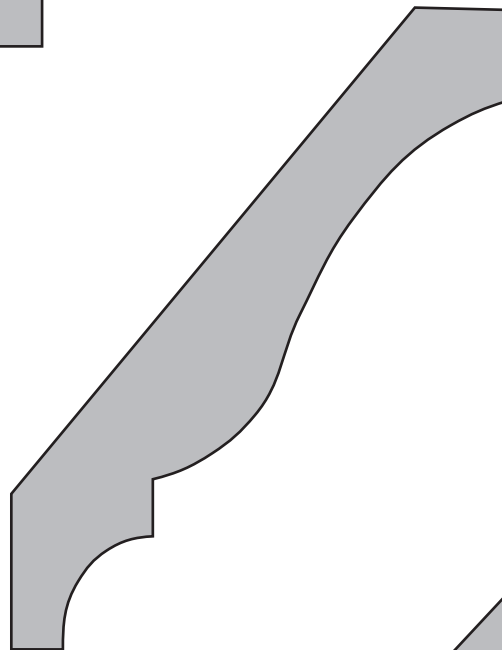

CM48 (WM48)  
9<sup>9</sup>/<sub>16</sub> X 4<sup>1</sup>/<sub>4</sub> in.

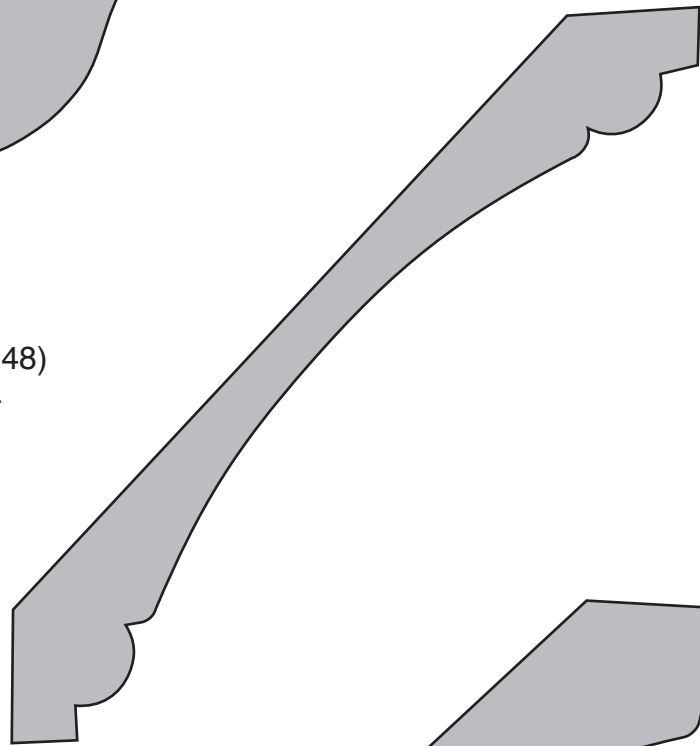

CM541  
1<sup>1</sup>/<sub>16</sub> X 5<sup>1</sup>/<sub>4</sub> in.

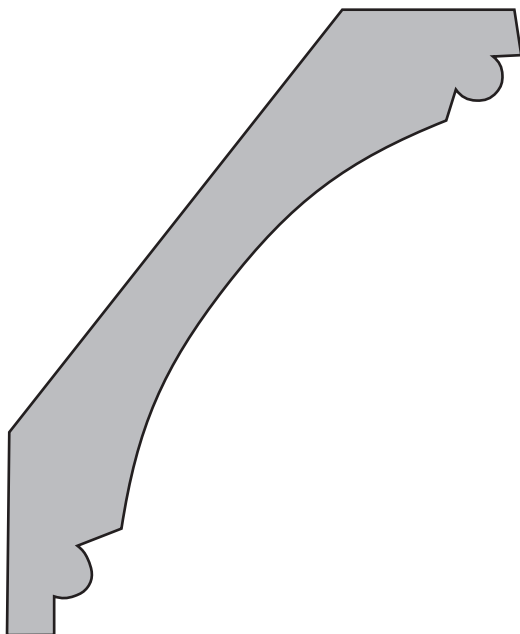

WM80  
1<sup>1</sup>/<sub>16</sub> X 4<sup>1</sup>/<sub>4</sub> in.



COLONIAL COVE  
3<sup>3</sup>/<sub>4</sub> X 5<sup>1</sup>/<sub>4</sub> in.

22

CARTER MILLWORK, INC.

# CROWN



Many more profiles available, call...1-800-861-0734 • FAX 1-800-861-0737

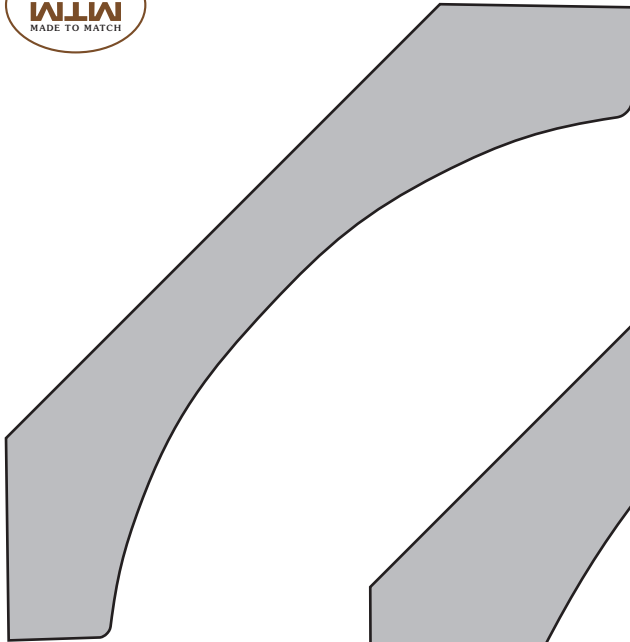

SM81  
1<sup>1</sup>/<sub>16</sub> X 4<sup>5</sup>/<sub>8</sub> in.  
Also Available:  
SM86  
1<sup>1</sup>/<sub>2</sub> X 6 in

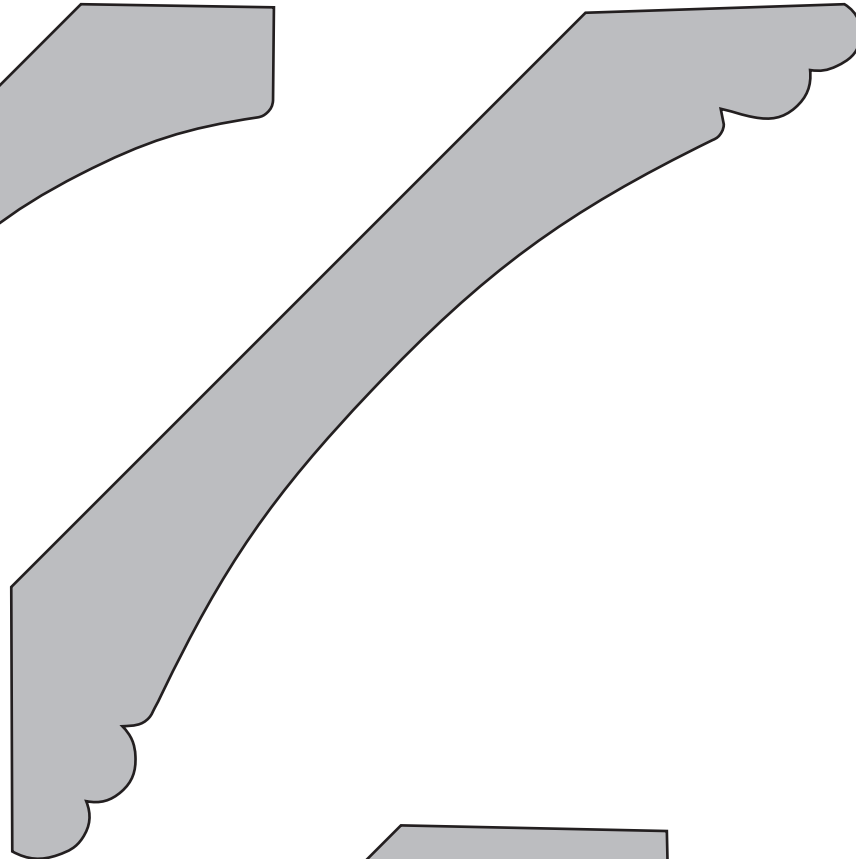

RBCCM625  
1 X 6<sup>1</sup>/<sub>4</sub> in.

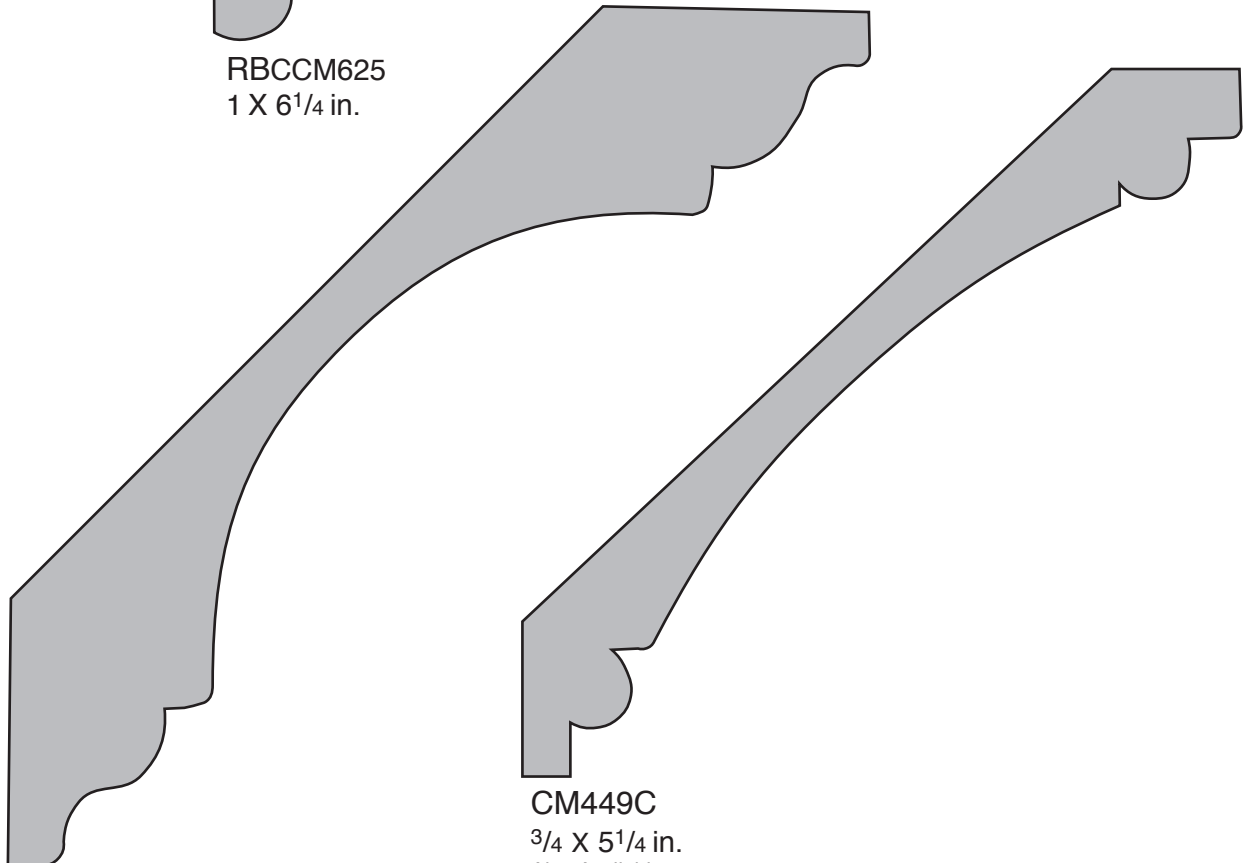

TP41/TLC500  
1<sup>1</sup>/<sub>8</sub> X 6<sup>1</sup>/<sub>4</sub> in.

CM449C  
3/4 X 5<sup>1</sup>/<sub>4</sub> in.  
Also Available:  
CM6449C  
3/4 X 6<sup>1</sup>/<sub>4</sub> in.

# CROWN



1-800-861-0734 • FAX 1-800-861-0737

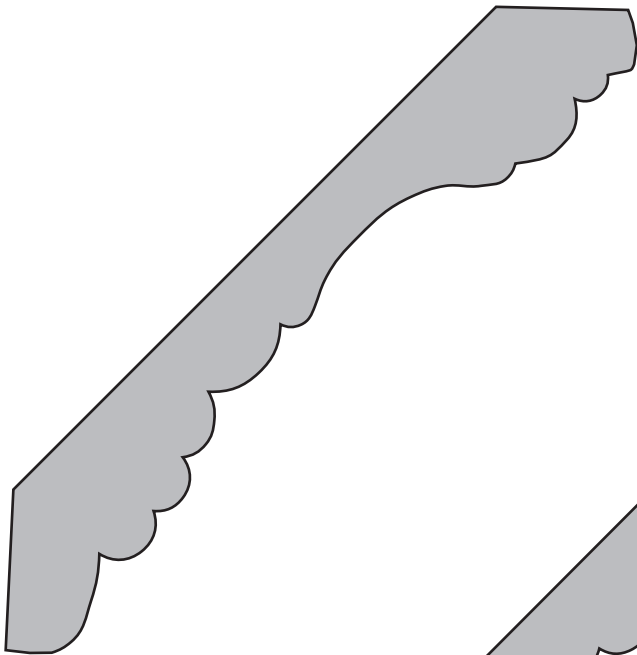

SM1136  
3/4 X 47/8 in.

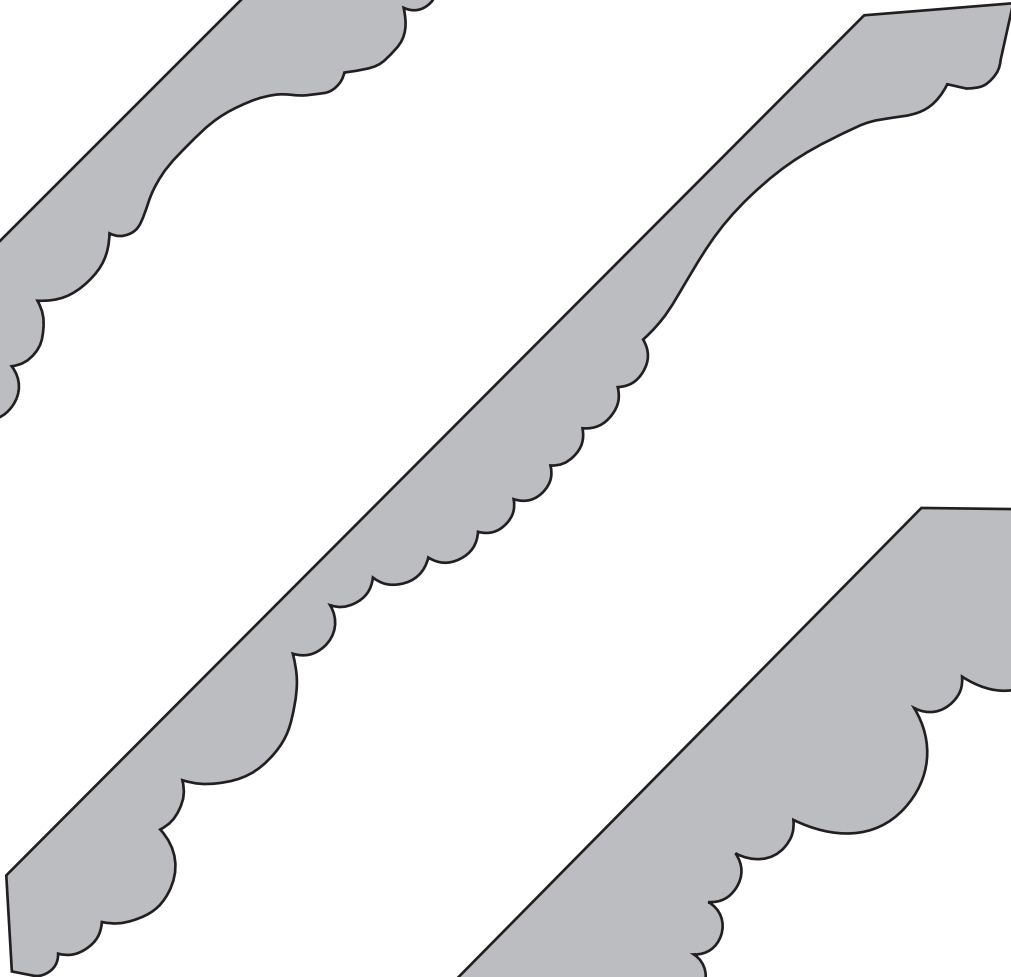

BBS725  
11/16 X 71/4 in.

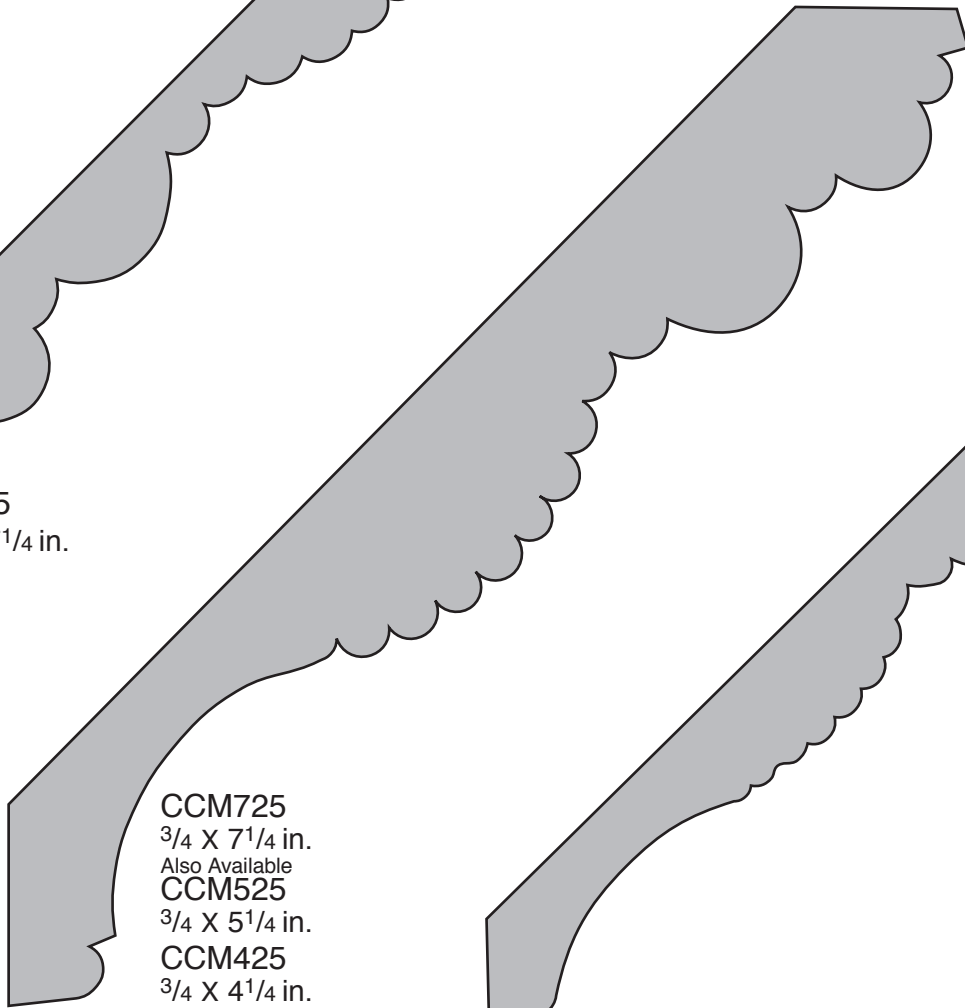

CCM725  
3/4 X 71/4 in.  
Also Available  
CCM525  
3/4 X 51/4 in.  
CCM425  
3/4 X 41/4 in.

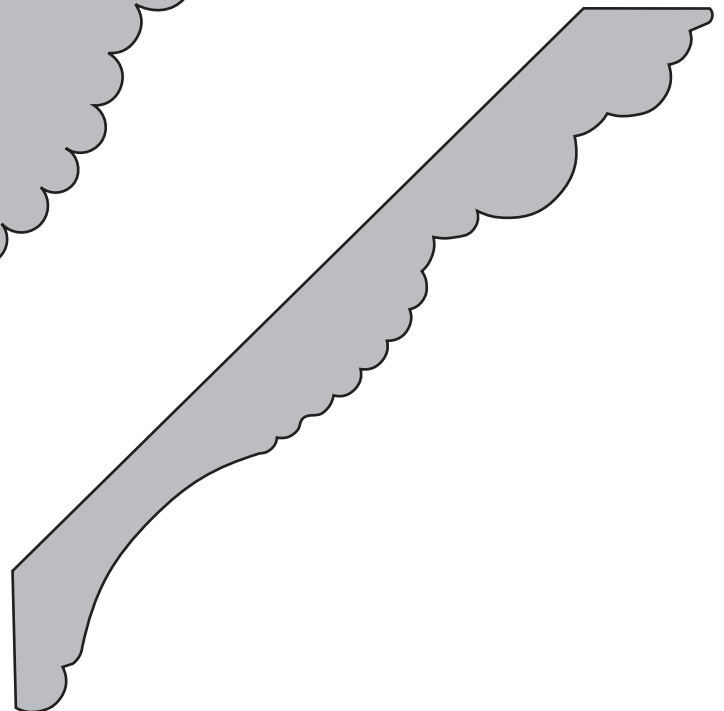

BBS111  
3/4 X 51/4 in.



# CROWN



Many more profiles available, call...1-800-861-0734 • FAX 1-800-861-0737

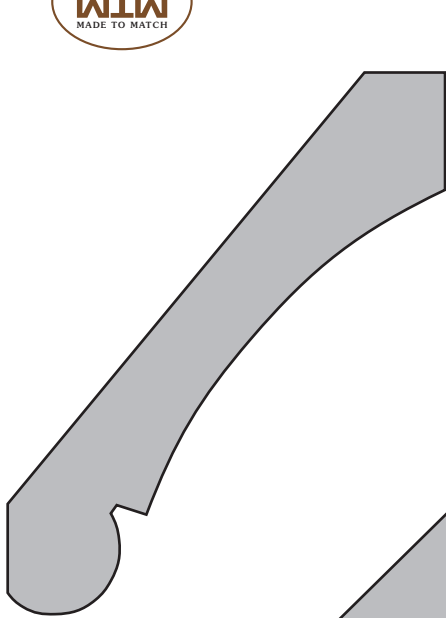

SM21  
1<sup>1</sup>/<sub>16</sub> X 3<sup>1</sup>/<sub>2</sub> in.

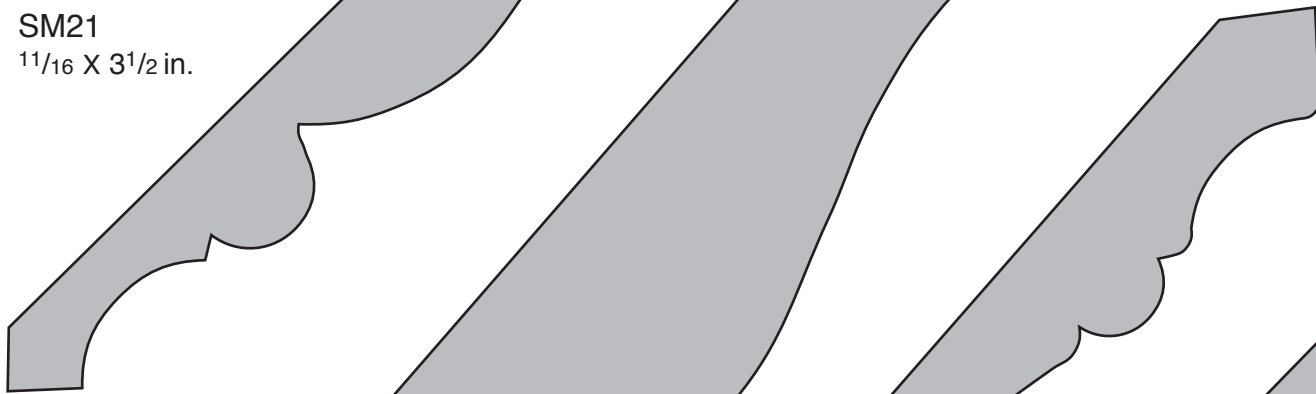

EC36  
1<sup>1</sup>/<sub>16</sub> X 7<sup>1</sup>/<sub>4</sub> in.

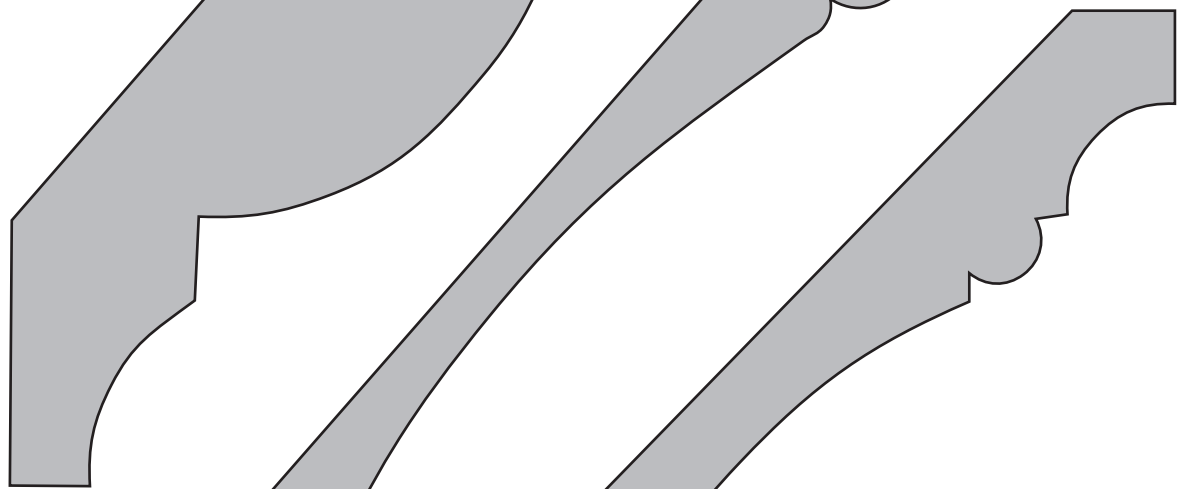

SM38  
1<sup>3</sup>/<sub>8</sub> X 8

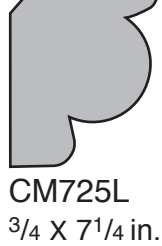

CM725L  
3/4 X 7<sup>1</sup>/<sub>4</sub> in.

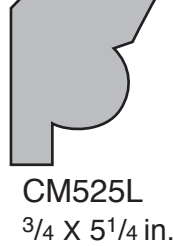

CM525L  
3/4 X 5<sup>1</sup>/<sub>4</sub> in.

# CROWN



1-800-861-0734 • FAX 1-800-861-0737

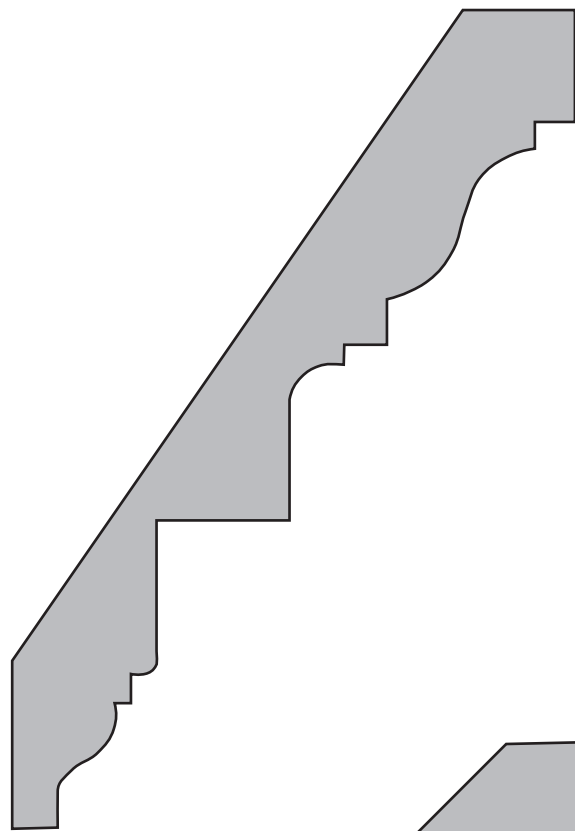

SM32  
3/4 X 5 1/4 in.

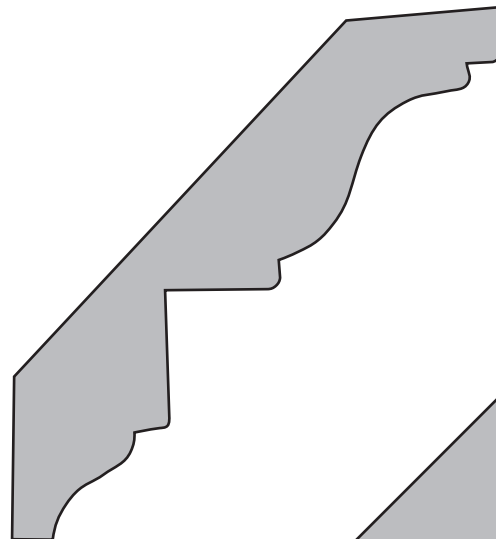

CM375L  
3/4 X 3 1/4 in.

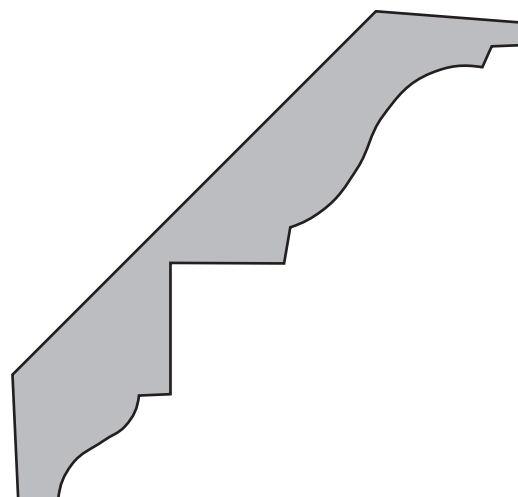

RB4  
5/8 X 3 1/2 in.

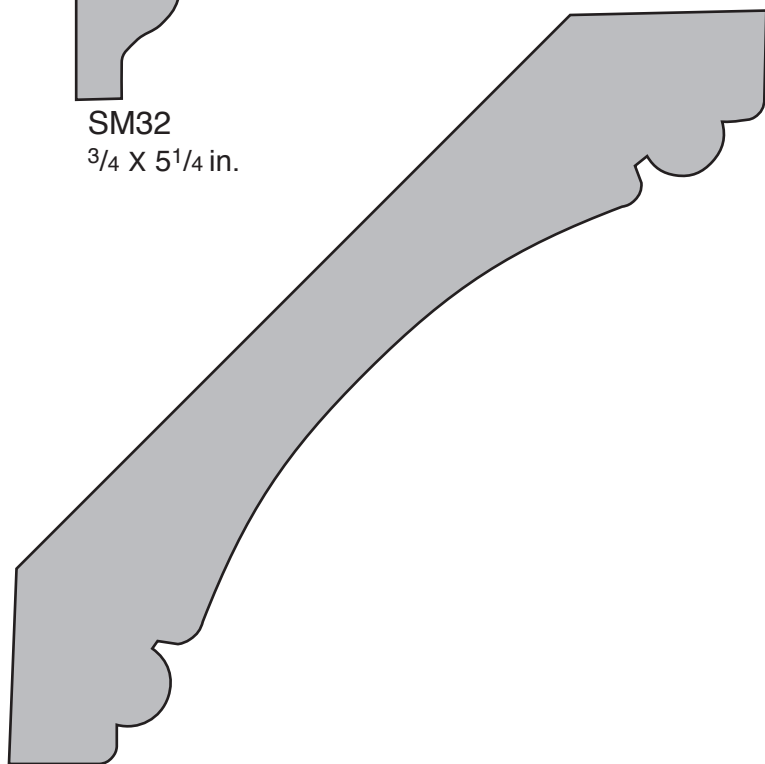

BM51245  
1 5/16 X 5 1/2 in.

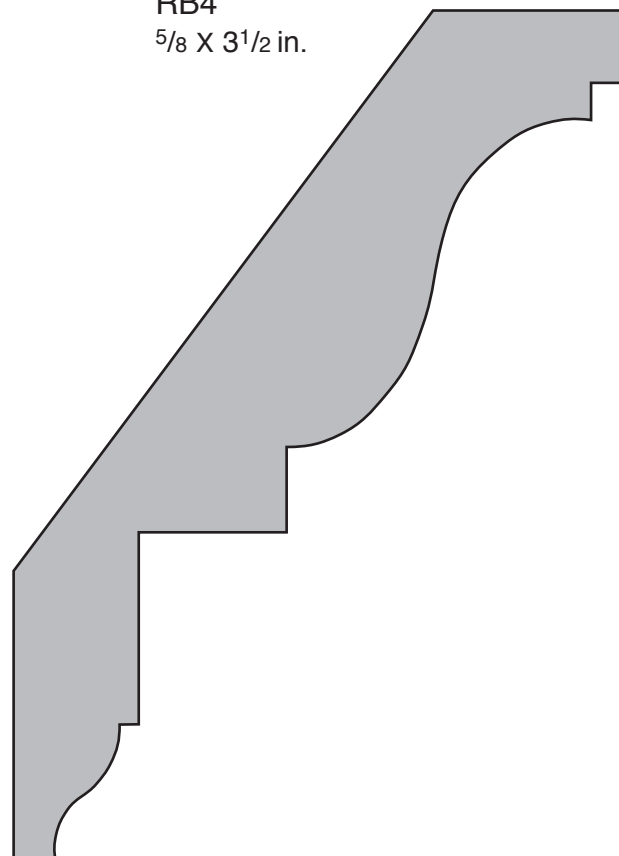

RB7  
1 1/16 X 5 1/4 in.

# CROWN



Many more profiles available, call...1-800-861-0734 • FAX 1-800-861-0737

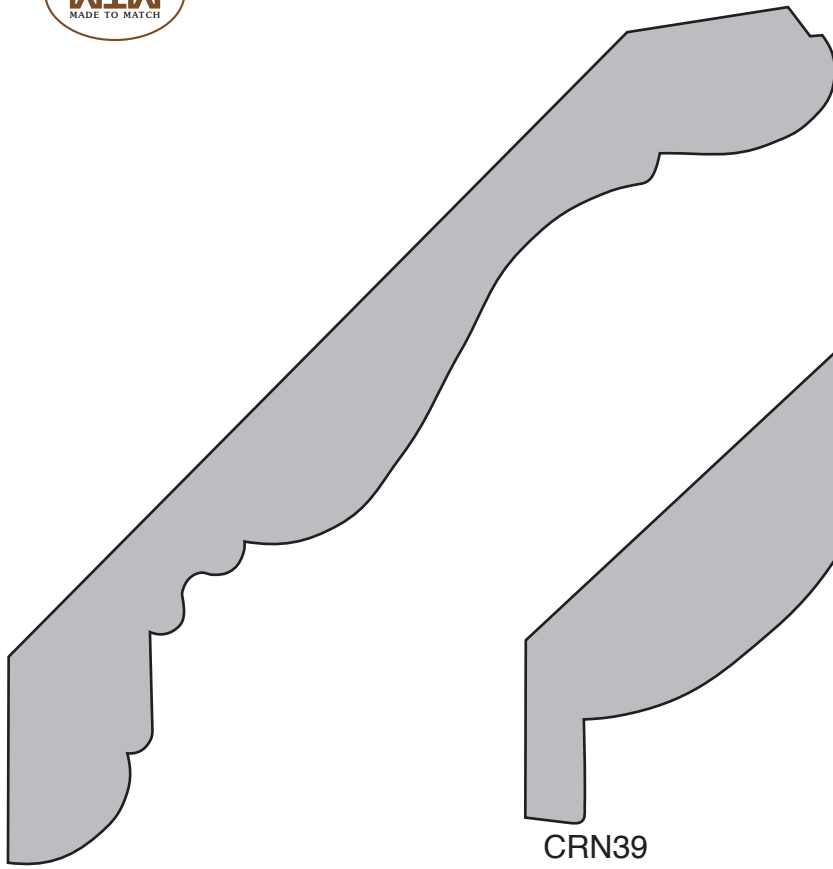

AH61  
1 X 6 in.

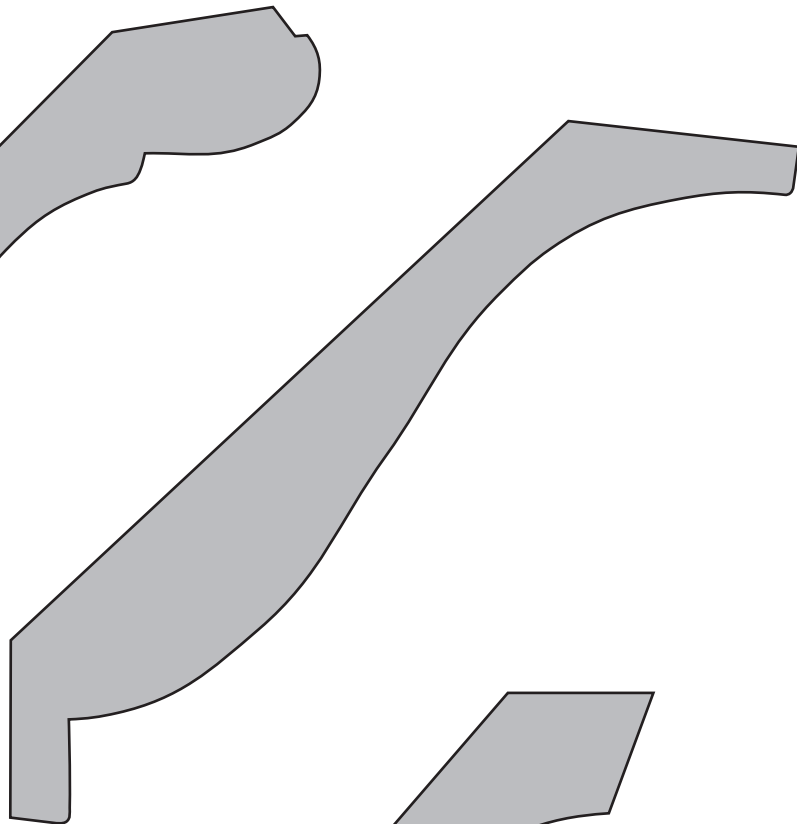

CRN39  
1 X 5<sup>1</sup>/<sub>4</sub> in.

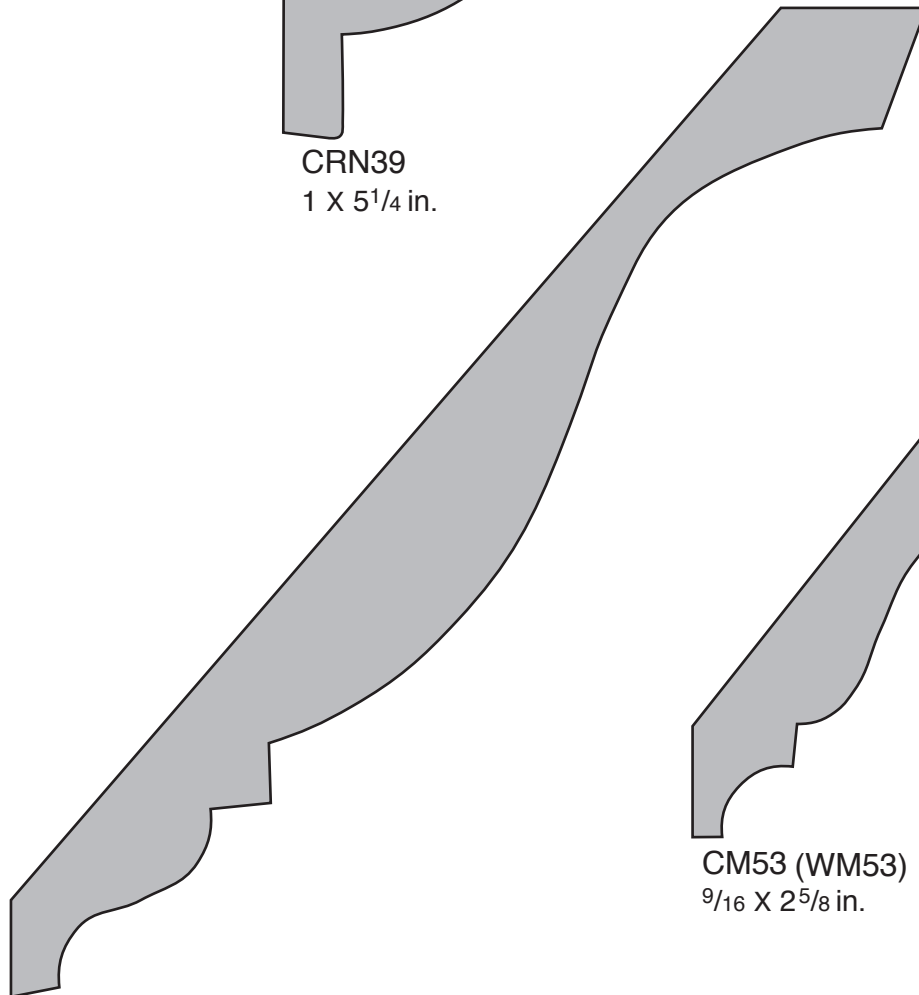

CM70(COX)  
3/4 X 7<sup>1</sup>/<sub>4</sub> in.

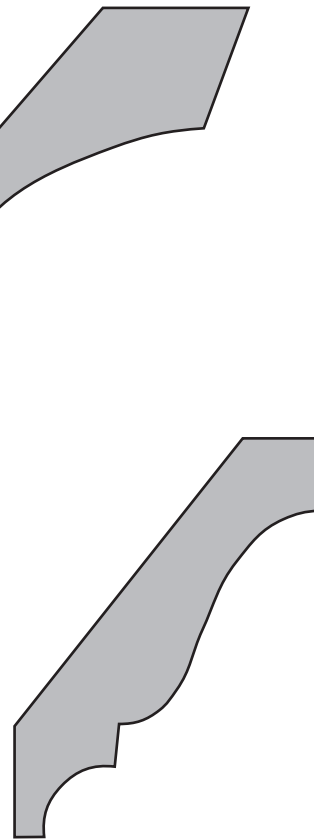

CM53 (WM53)  
9/16 X 2<sup>5</sup>/<sub>8</sub> in.

# CROWN



1-800-861-0734 • FAX 1-800-861-0737

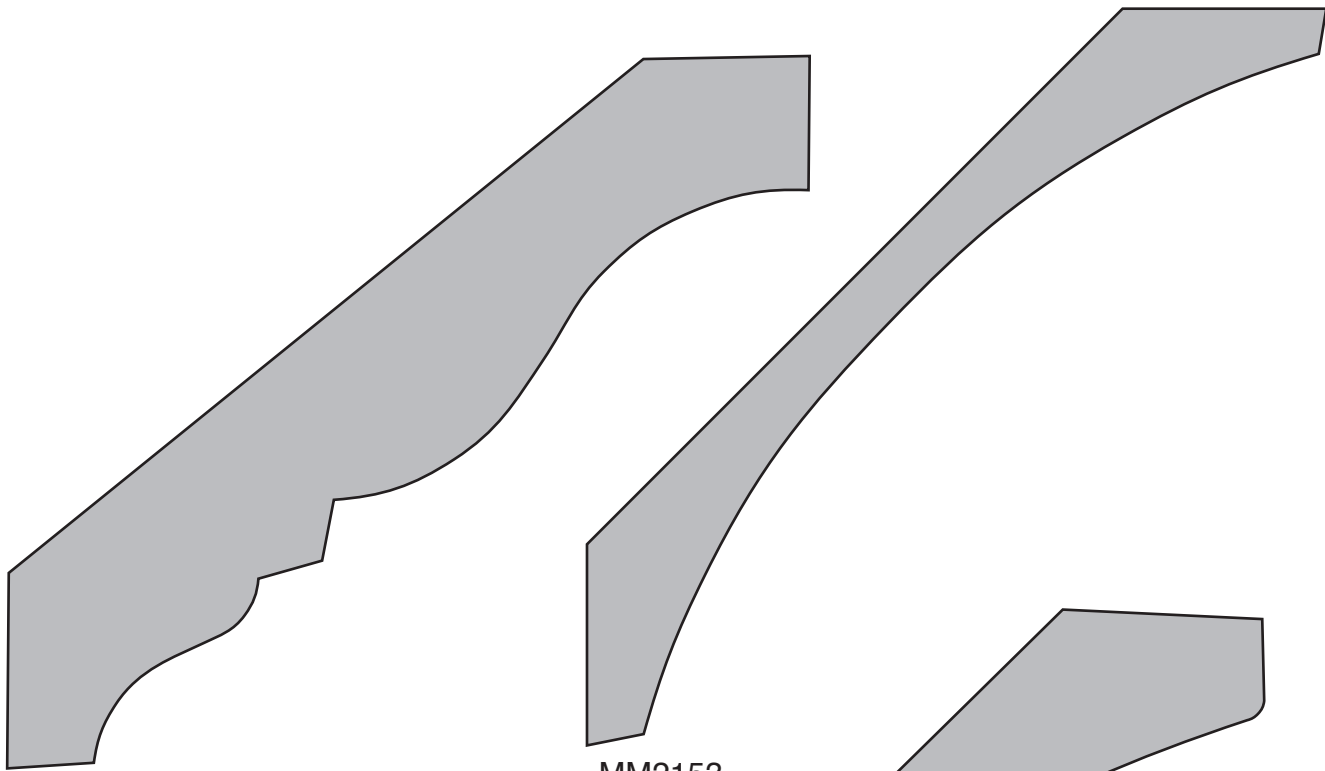

MTV629  
1 X 5<sup>3</sup>/<sub>4</sub> in.

MM2153  
9/16 X 5<sup>1</sup>/<sub>4</sub> in.

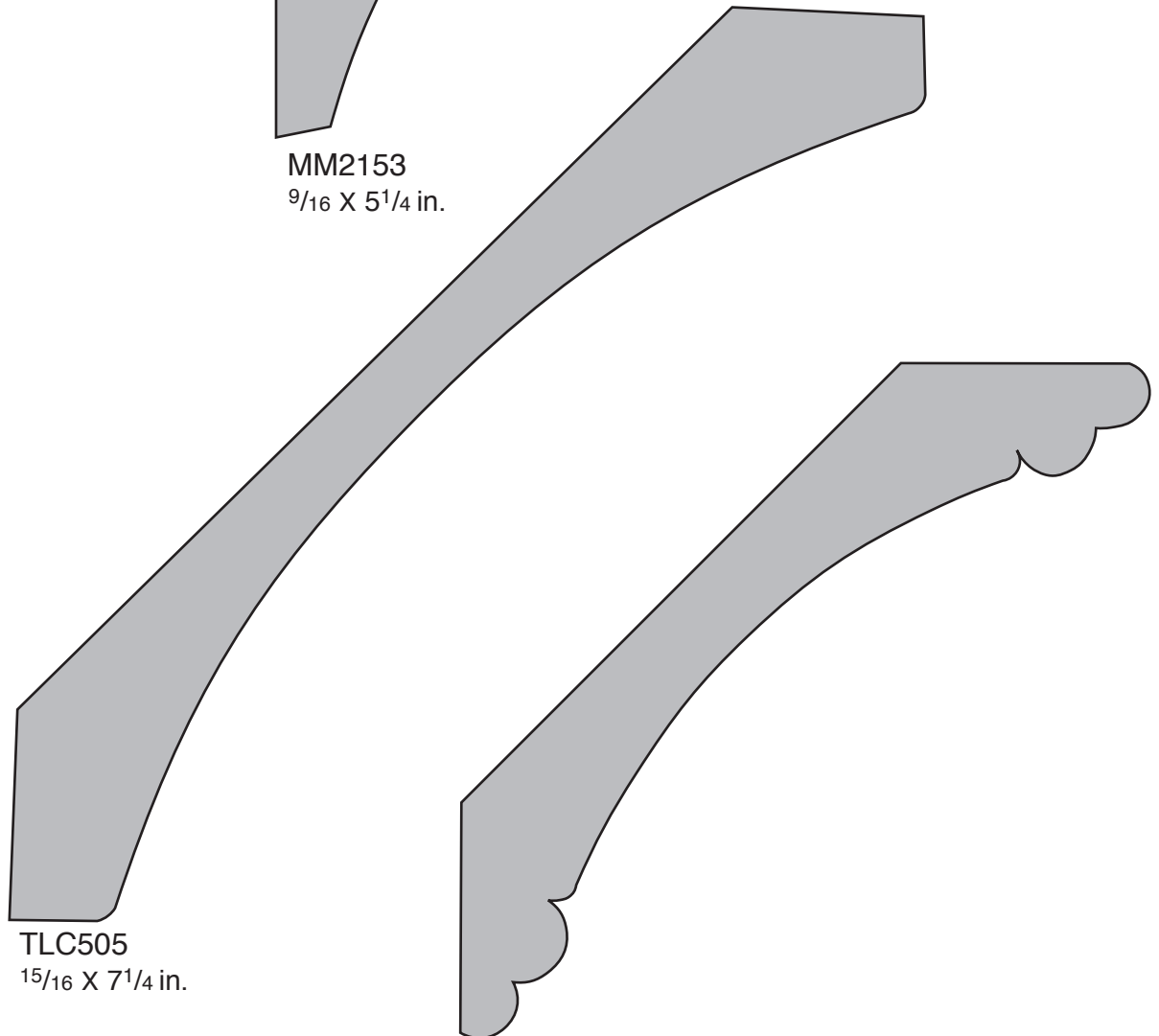

TLC505  
1<sup>5</sup>/<sub>16</sub> X 7<sup>1</sup>/<sub>4</sub> in.

RBCCM525  
1 X 5<sup>1</sup>/<sub>4</sub> in.

# CROWN



Many more profiles available, call...1-800-861-0734 • FAX 1-800-861-0737

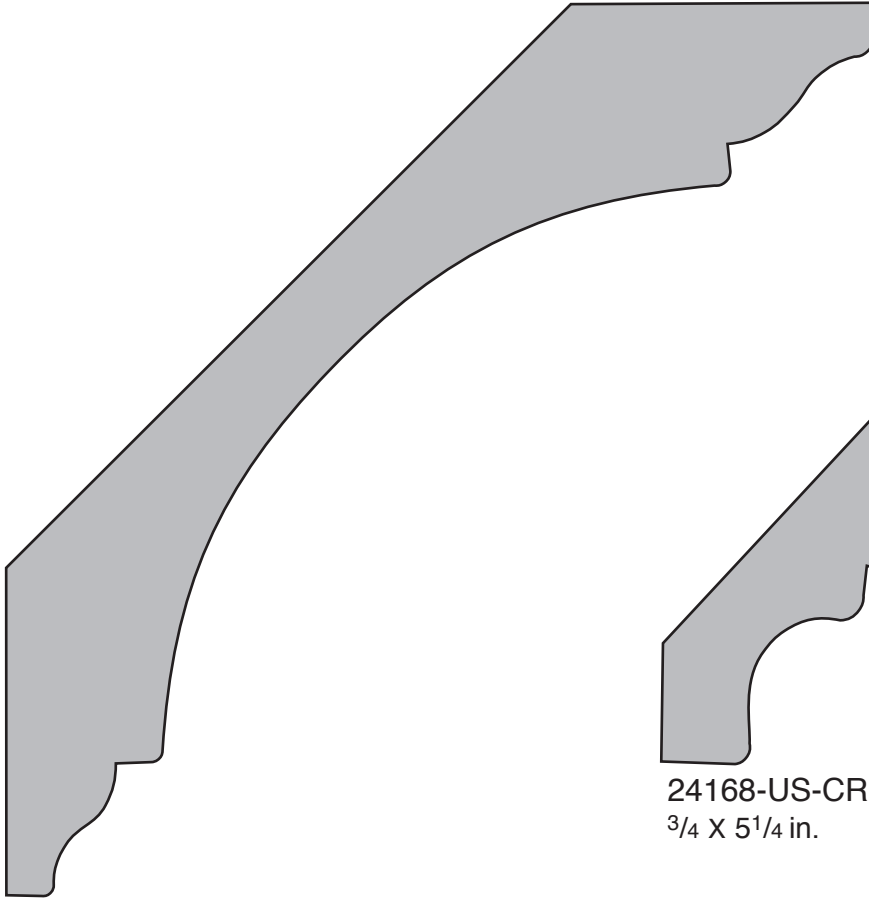

CBM1554  
1<sup>1</sup>/<sub>4</sub> X 6<sup>1</sup>/<sub>2</sub> in.

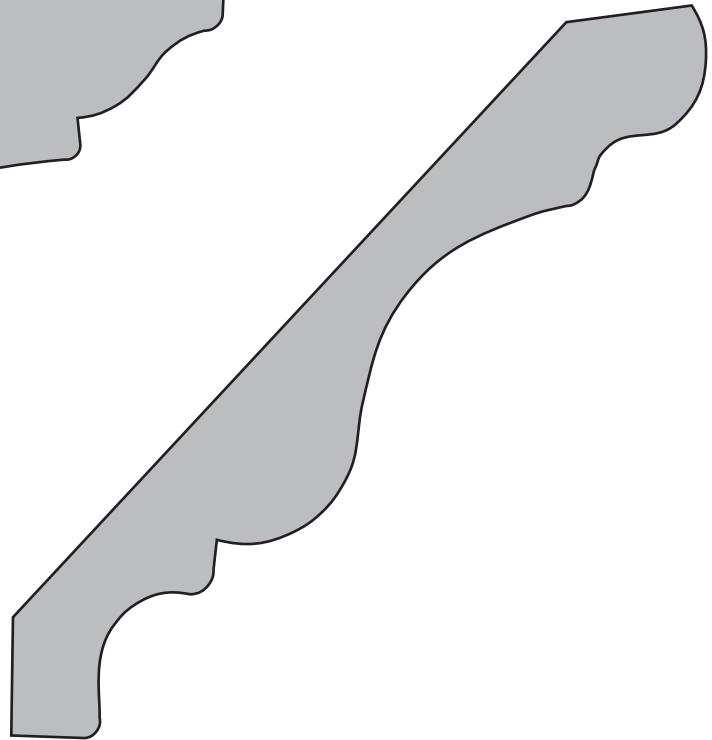

24168-US-CR  
3<sup>3</sup>/<sub>4</sub> X 5<sup>1</sup>/<sub>4</sub> in.

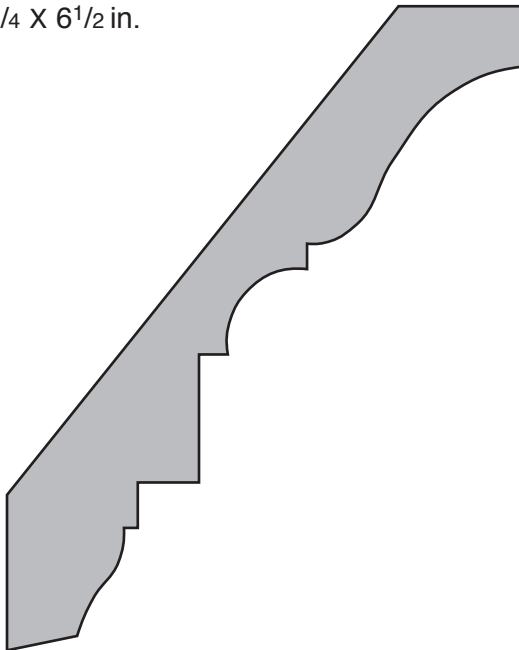

EC9  
1<sup>1</sup>/<sub>16</sub> X 4<sup>1</sup>/<sub>4</sub> in.

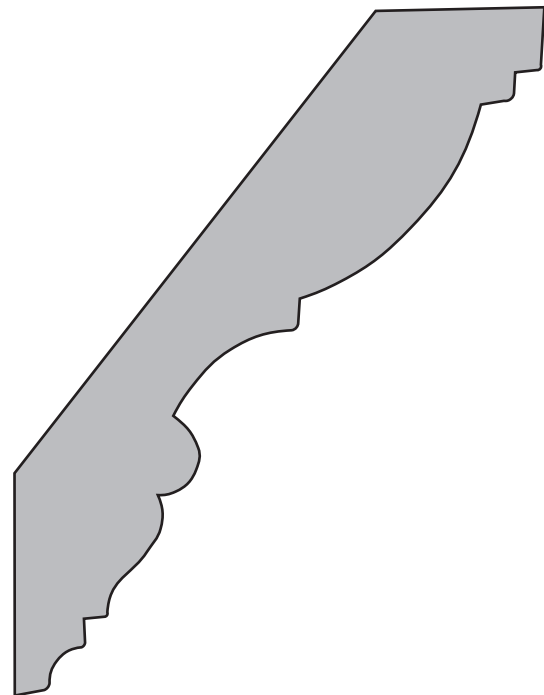

SM712  
7<sup>7</sup>/<sub>8</sub> X 4<sup>1</sup>/<sub>2</sub> in.

# CROWN



1-800-861-0734 • FAX 1-800-861-0737

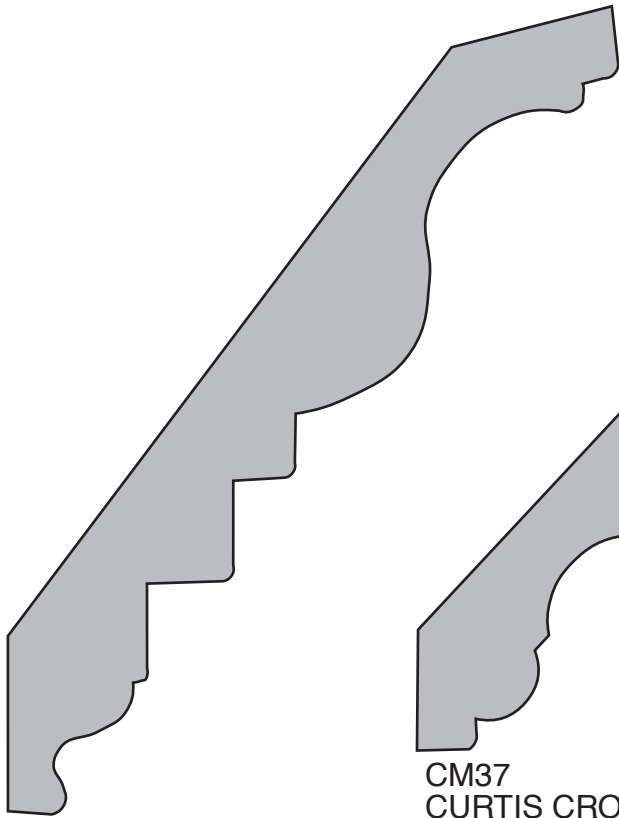

CM549  
3/4 X 5 1/4 in.

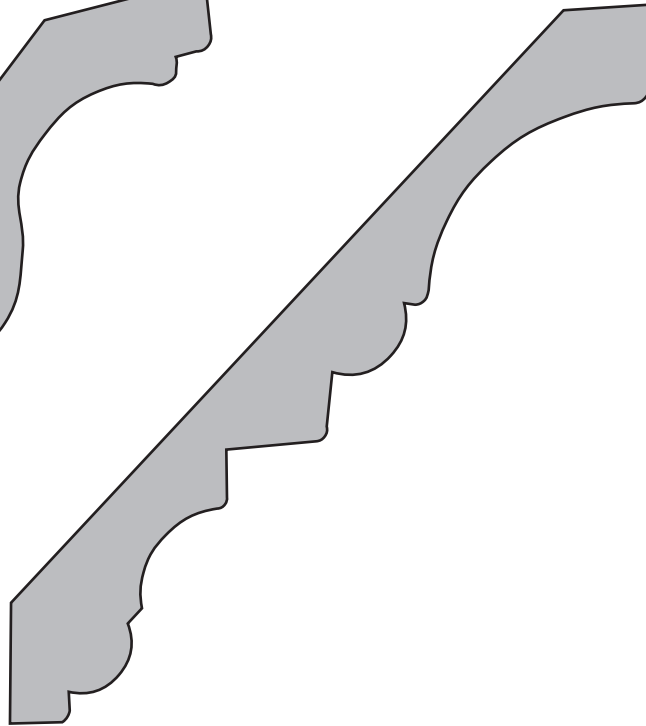

CM37  
CURTIS CROWN  
1 1/16 X 5 1/16 in.

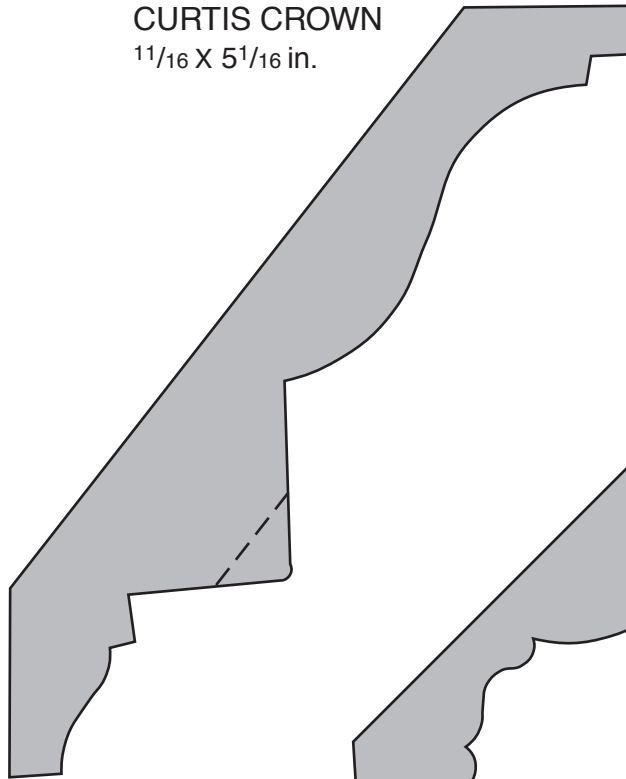

SMITH DENTIL CRN  
1 3/16 X 5 5/16 in.

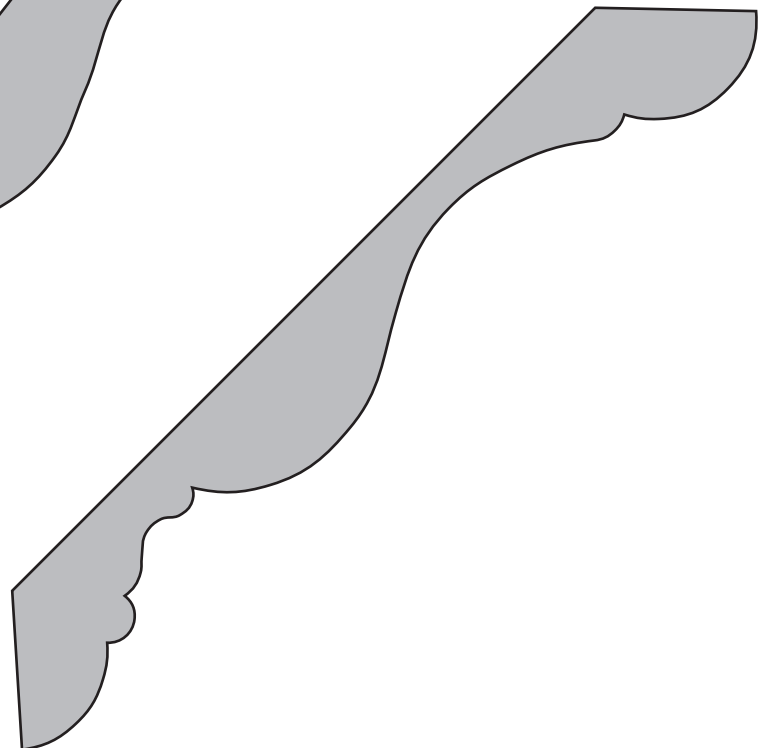

SM1157  
3/4 X 5 3/8 in.

# CROWN



Many more profiles available, call...1-800-861-0734 • FAX 1-800-861-0737

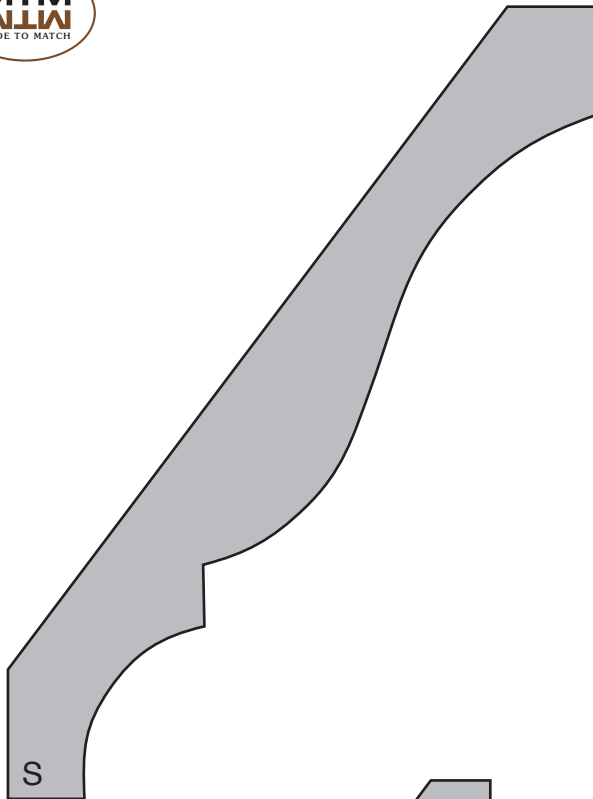

CM45 (EC045)  
(1-1/8" Cove)  
11/16 X 5 1/4 in.

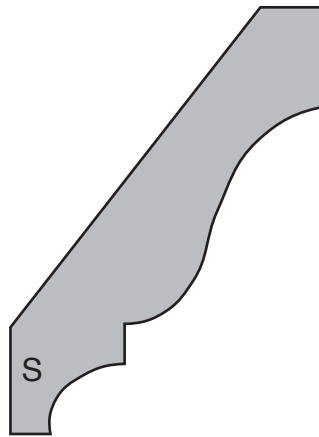

CM52 (WM052)  
9/16 X 2 3/4 in.

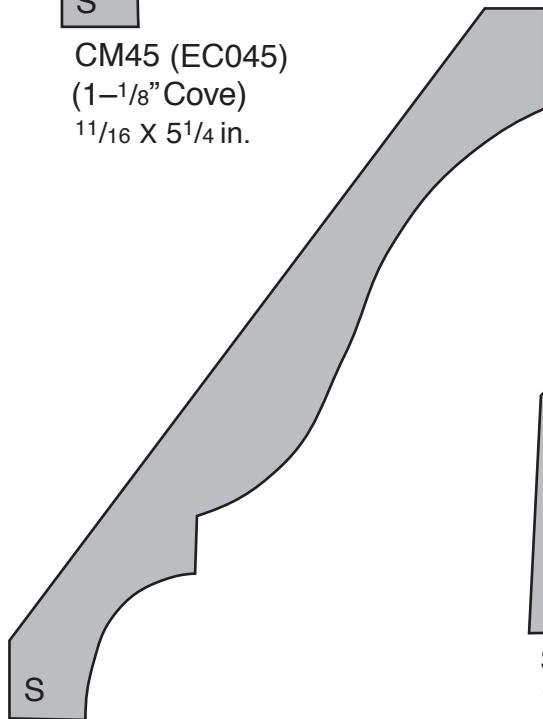

CM47 (WM047)  
9/16 X 4 5/8 in.

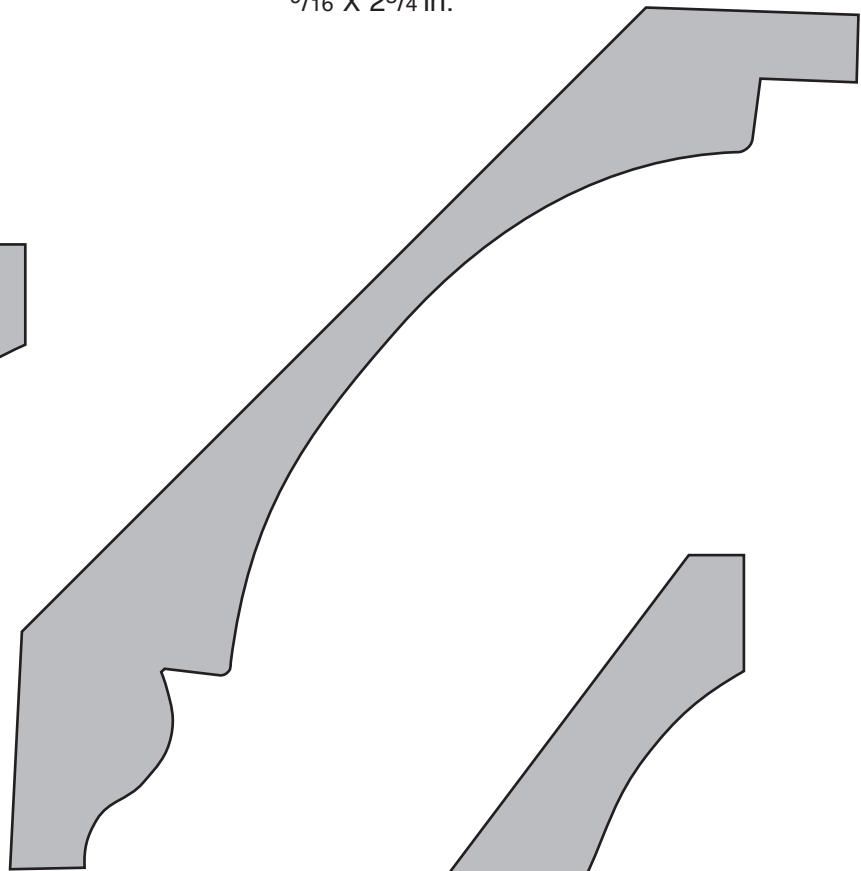

SM1160  
1 3/4 X 6 1/4 in.

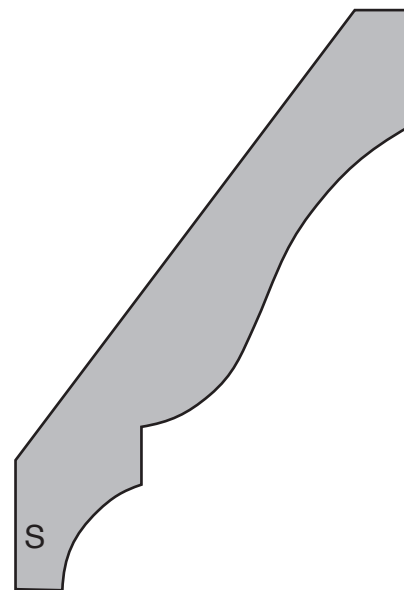

CM49 (WM049)  
9/16 X 3 5/8 in.

# CROWN



1-800-861-0734 • FAX 1-800-861-0737

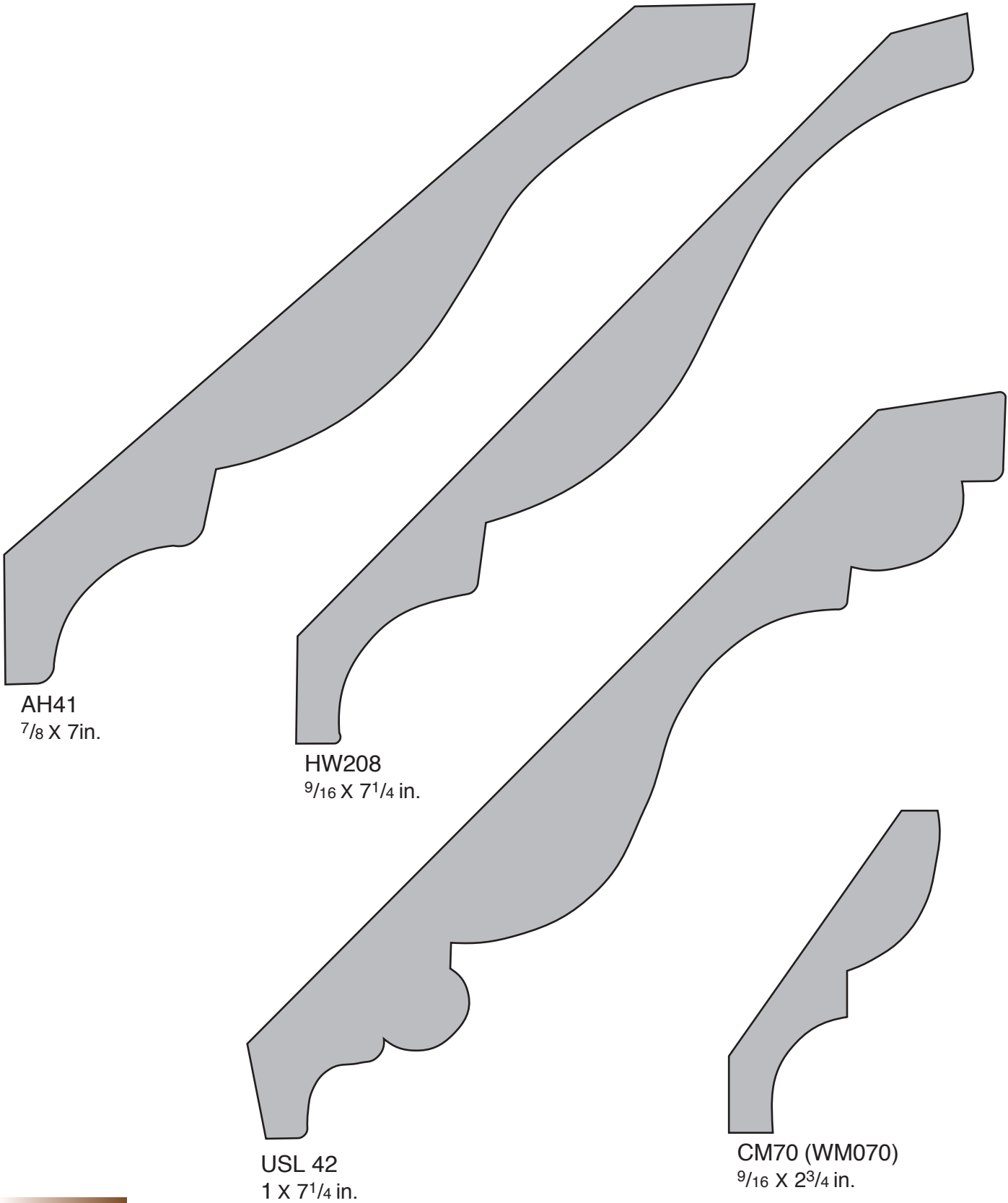



# CROWN

**FLEX TRIM™**

by CARTER MILLWORK

*Many more profiles available, call...1-800-861-0734 • FAX 1-800-861-0737*

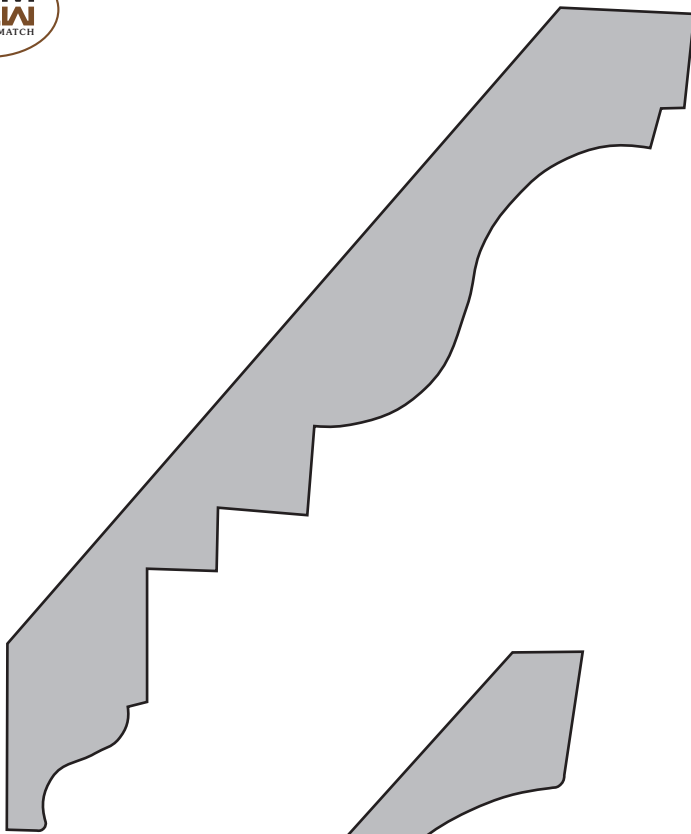

MCM 20-5  
3/4 X 5 1/2 in.

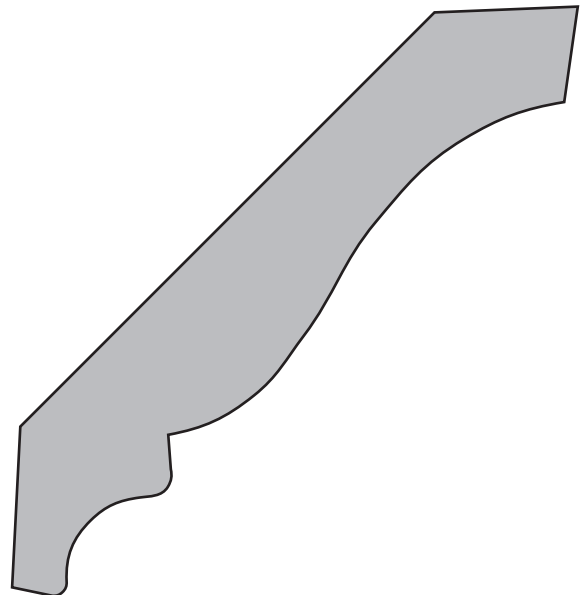

COX48  
3/4 X 4 1/4 in.

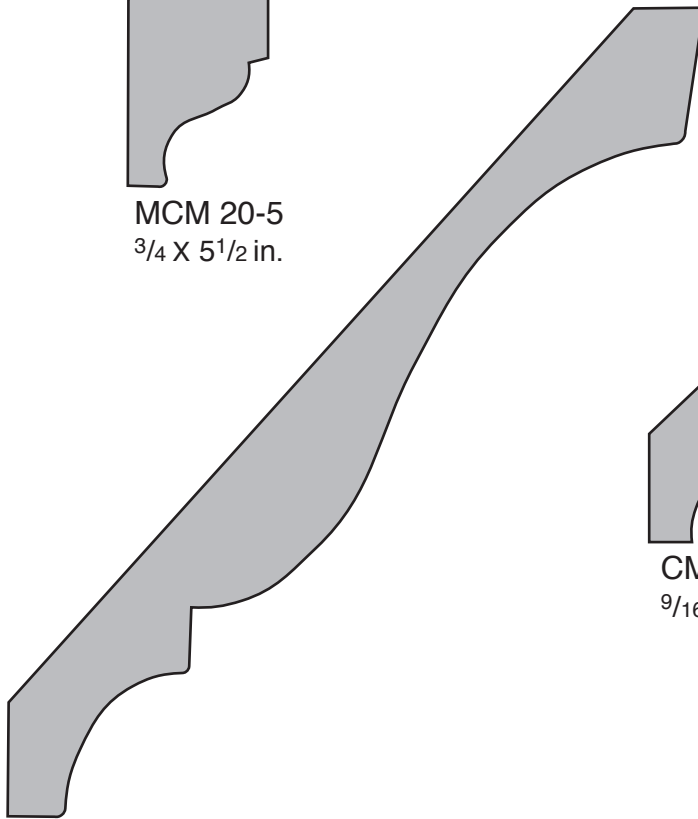

CM17  
1 1/16 X 5 5/8 in.

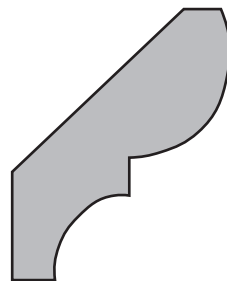

CM74 (WM074)  
9/16 X 1 3/4 in.

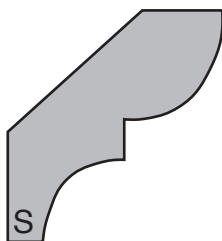

CM75 (WM075)  
9/16 X 1 5/8 in.

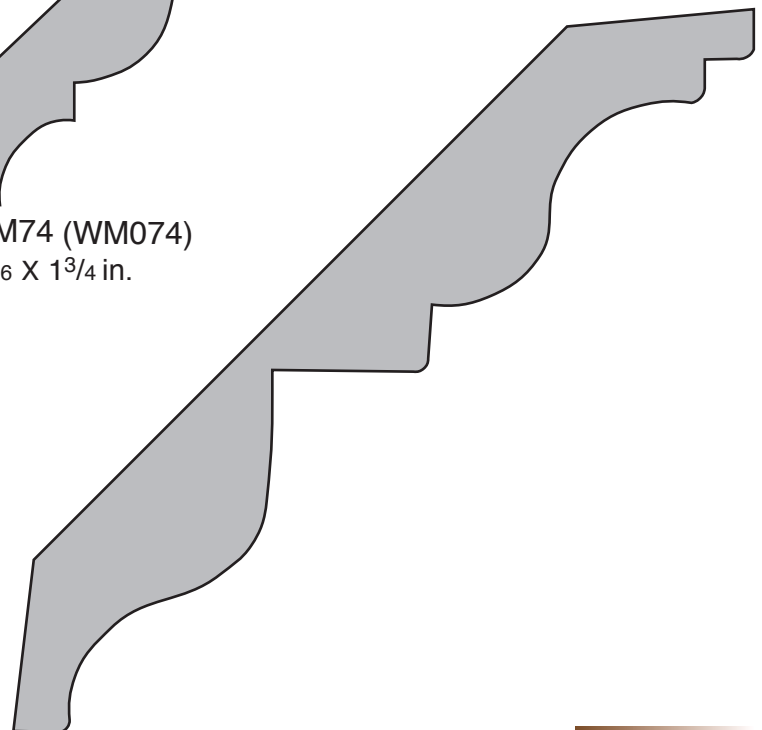

CM49L  
3/4 X 5 1/4 in.

# CROWN BACKER



1-800-861-0734 • FAX 1-800-861-0737

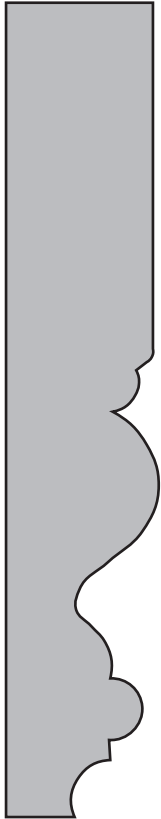

SM4008  
3/4 X 4 1/4 in.

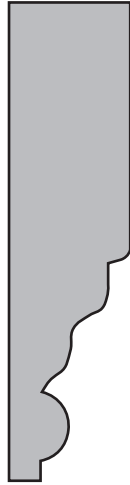

CRB250  
5/8 X 2 1/2 in.



AH19  
5/8 X 4 15/16 in.



CM2  
1 1/16 X 2 1/2 in.



WINDSOR  
5/8 X 3 1/4 in.

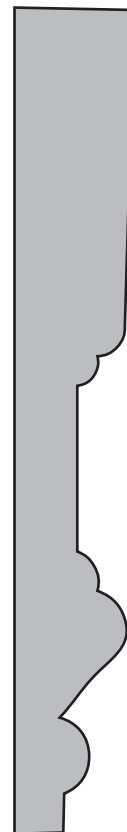

1701  
5/8 X 4 5/16 in.

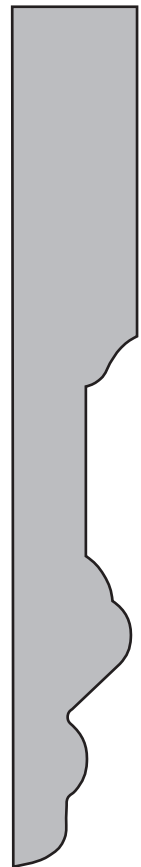

TLC599  
5/8 X 4 1/2 in.

# BASES



Many more profiles available, call...1-800-861-0734 • FAX 1-800-861-0737

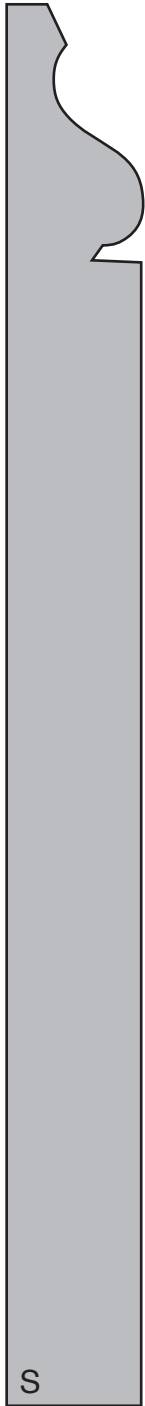

**AH810**  
5/8 X 7 1/4 in.



**CM618 (WM618)**  
9/16 X 5 1/4 in.



**CM710 (WM710)**  
9/16 X 4 1/4 in.



**CM663 (WM663)**  
9/16 X 3 1/4 in.



**BCB500**  
5/8 X 5 1/4 in.  
Also Available:  
**BCB300**  
5/8 X 3 1/4 in.  
**BCB400**  
5/8 X 4 1/4 in.  
**BCB700**  
5/8 X 7 1/4 in.  
**BCB925**  
3/4 X 9 1/4 in.



**MS5180**  
9/16 X 5 1/4 in.

# BASES



1-800-861-0734 • FAX 1-800-861-0737



612  
9/16 X 6 9/16 in.



SM97  
3/4 X 5 1/2 in.



CM610  
9/16 X 5 1/4 in.



CM623 (WM623)  
9/16 X 3 1/4 in.



CM753  
9/16 X 3 1/4 in.  
Also Available:  
CM750  
9/16 X 4 1/4 in.  
CM750W  
9/16 X 5 1/4 in.



CM218  
9/16 X 5 1/4 in.

# BASES



Many more profiles available, call...1-800-861-0734 • FAX 1-800-861-0737



S  
CM616 (EC616)  
1<sup>1</sup>/<sub>16</sub> X 6<sup>1</sup>/<sub>8</sub> in.

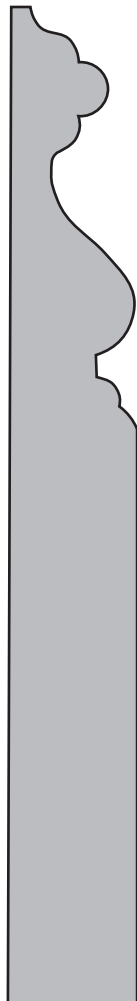

TWPB  
1<sup>1</sup>/<sub>16</sub> X 5<sup>1</sup>/<sub>4</sub> in.

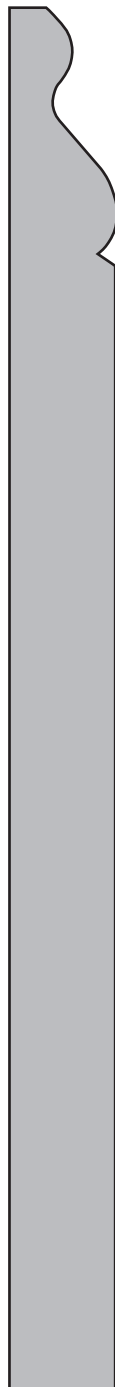

MDF714  
5/8 X 7<sup>1</sup>/<sub>4</sub> in.



BBJ725  
3/4 X 7<sup>1</sup>/<sub>4</sub> in.

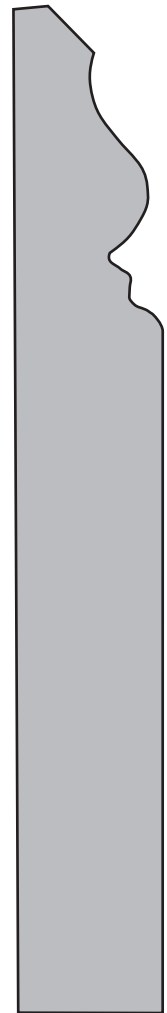

BBJ525  
3/4 X 5<sup>1</sup>/<sub>4</sub> in.  
Also Available:  
BBJ325  
3/4 X 3<sup>1</sup>/<sub>4</sub> in.  
BBJ425  
3/4 X 4<sup>1</sup>/<sub>4</sub> in.

# BASES



1-800-861-0734 • FAX 1-800-861-0737

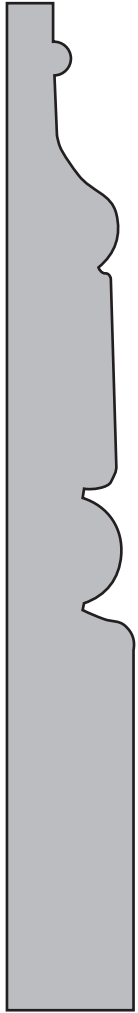

**BLB525**  
5/8 X 5 1/4 in.

Also Available:

**BLB425**  
5/8 X 4 1/4 in.

**BLB725**  
5/8 X 7 1/4 in.

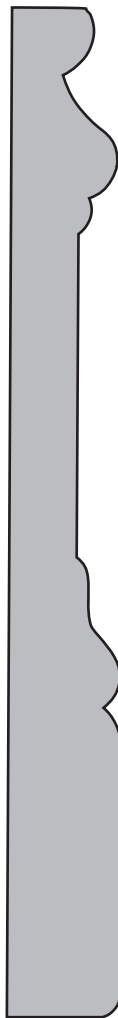

**VICTORIAN BASE**  
9/16 X 5 1/4 in.



**MBC38-5**  
3/4 X 5 1/4 in.



**LDFBA718**  
5/8 X 7 1/8 in.

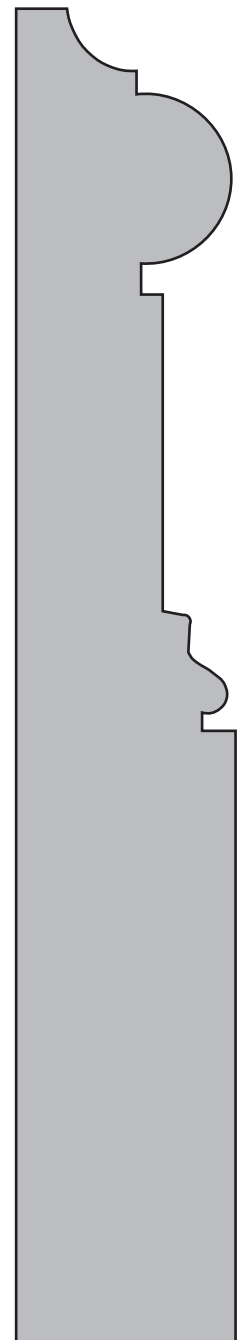

**AH617**  
1 1/8 X 7 in.

# BASE CAPS



Many more profiles available, call...1-800-861-0734 • FAX 1-800-861-0737

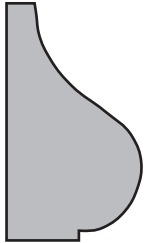

CM166  
(WM166)  
1<sup>1</sup>/<sub>16</sub> X 1<sup>1</sup>/<sub>4</sub>in.

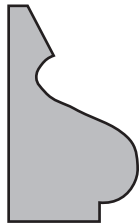

CM164  
(WM164)  
1<sup>1</sup>/<sub>16</sub> X 1<sup>1</sup>/<sub>8</sub>in.

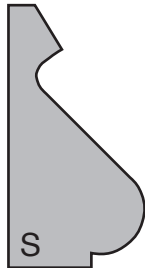

CM163  
(WM163)  
1<sup>1</sup>/<sub>16</sub> X 1<sup>3</sup>/<sub>8</sub>in.

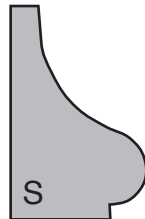

CM167  
(WM167)  
1<sup>1</sup>/<sub>16</sub> X 1<sup>1</sup>/<sub>8</sub>in.



1201  
1<sup>1</sup>/<sub>16</sub> X 1<sup>1</sup>/<sub>4</sub>in.

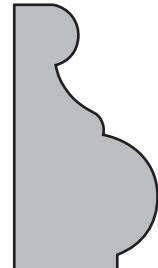

SM30  
3/4 X 1<sup>3</sup>/<sub>8</sub>in.

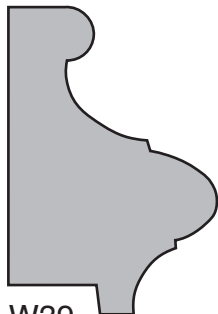

W39  
1<sup>1</sup>/<sub>8</sub> X 1<sup>1</sup>/<sub>2</sub>in.

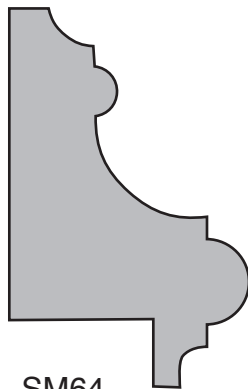

SM64  
1<sup>1</sup>/<sub>4</sub> X 2in.

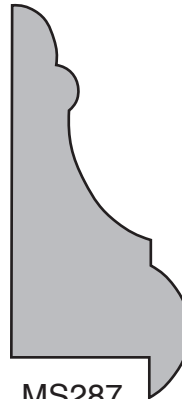

MS287  
1<sup>7</sup>/<sub>8</sub> X 2<sup>1</sup>/<sub>16</sub>in.



SM54  
5/8 X 1<sup>3</sup>/<sub>8</sub>in.

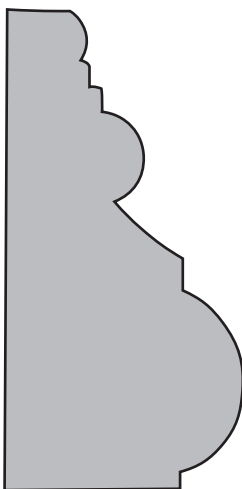

SM43  
1<sup>1</sup>/<sub>4</sub> X 2<sup>1</sup>/<sub>2</sub>in.

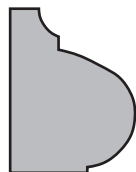

LWP 114  
1<sup>1</sup>/<sub>16</sub> X 7/8in.

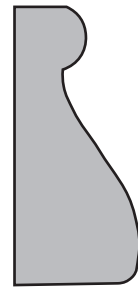

BCB 150  
1<sup>1</sup>/<sub>16</sub> X 1<sup>1</sup>/<sub>2</sub>in.



SM40  
7/8 X 1<sup>7</sup>/<sub>8</sub>in.

# CHAIR RAIL



1-800-861-0734 • FAX 1-800-861-0737

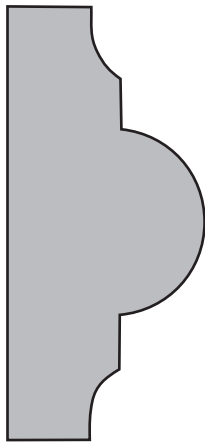

C136  
1<sup>1</sup>/<sub>16</sub> X 2<sup>1</sup>/<sub>4</sub> in.

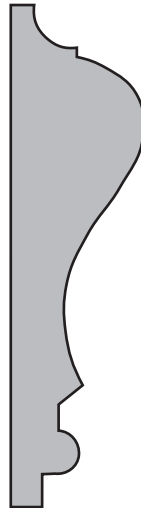

CM390 (WM390)  
1<sup>1</sup>/<sub>16</sub> X 2<sup>5</sup>/<sub>8</sub> in.

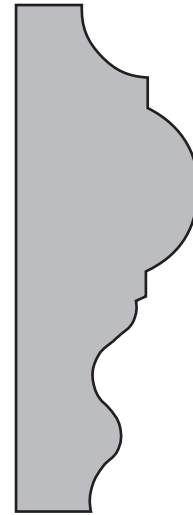

4  
1<sup>5</sup>/<sub>16</sub> X 2<sup>5</sup>/<sub>8</sub> in.

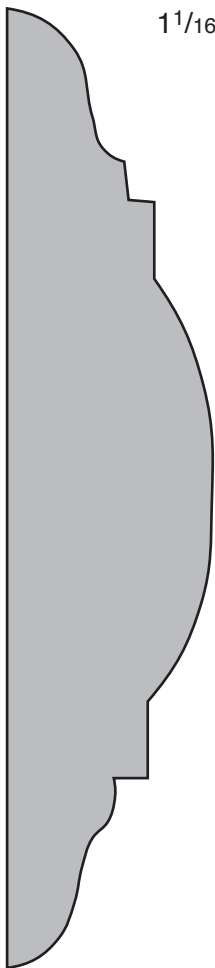

CR560  
1 X 5 in.

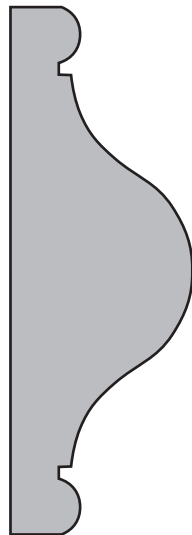

CM302  
1<sup>1</sup>/<sub>16</sub> X 2<sup>3</sup>/<sub>4</sub> in.

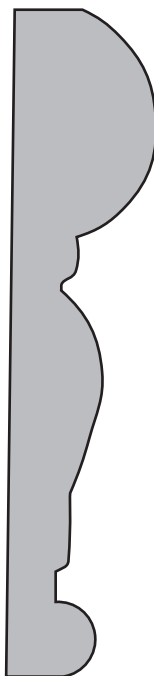

CR290  
3/4 X 3<sup>1</sup>/<sub>2</sub> in.

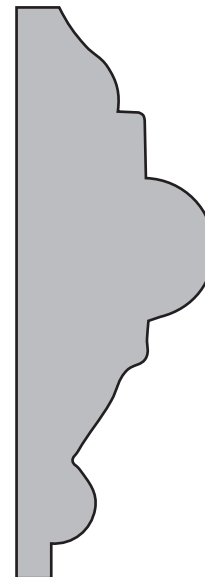

CRAL333  
1 X 3 in.

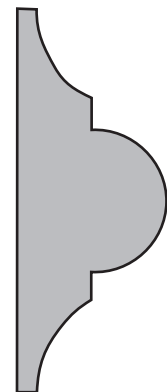

HH133  
3/4 X 2 in.



# CHAIR RAIL



Many more profiles available, call...1-800-861-0734 • FAX 1-800-861-0737

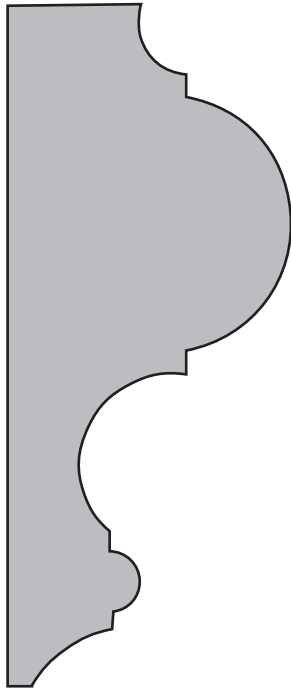

SM225  
1<sup>3</sup>/<sub>8</sub> X 3<sup>5</sup>/<sub>8</sub> in.

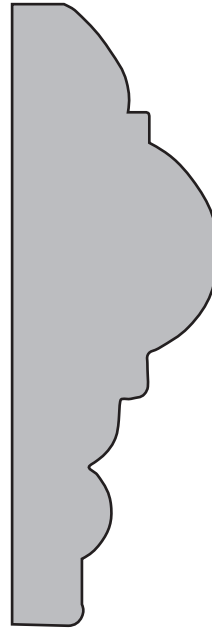

MD4  
1<sup>1</sup>/<sub>16</sub> X 3<sup>1</sup>/<sub>4</sub> in.

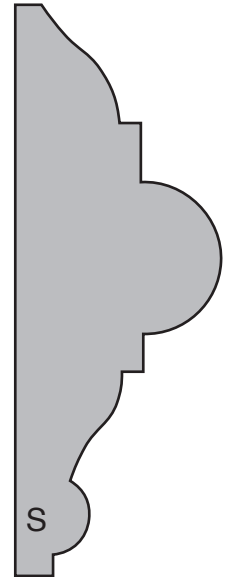

CM300 (WM300)  
1<sup>1</sup>/<sub>16</sub> X 3 in.

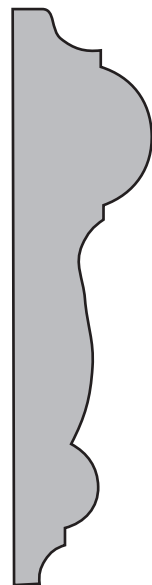

CM297  
1<sup>1</sup>/<sub>16</sub> X 3 in.

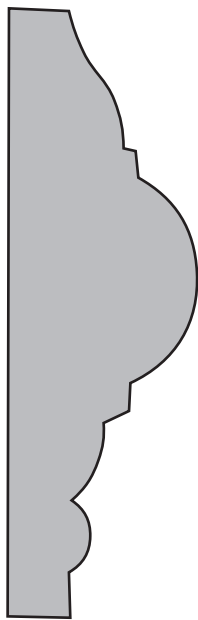

GP200  
1 X 3<sup>1</sup>/<sub>4</sub> in.



CRA350  
3/4 X 3<sup>1</sup>/<sub>2</sub> in.

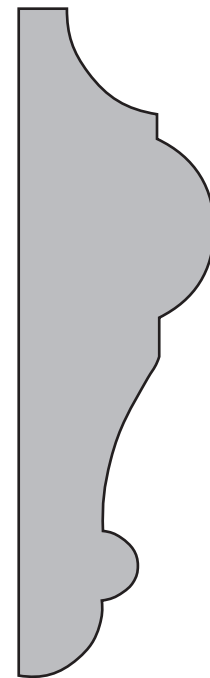

CM397  
1 X 3<sup>1</sup>/<sub>2</sub> in.

# CHAIR RAIL BACKE



1-800-861-0734 • FAX 1-800-861-0737

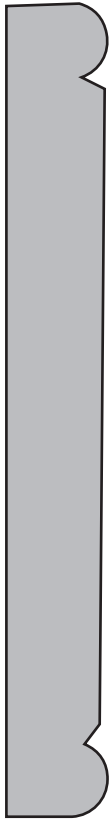

CM957  
(WM957)  
1/2 X 4 1/4 in.

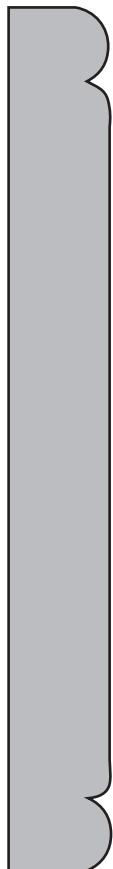

CM425 (C135)  
1/2 X 4 1/2 in.

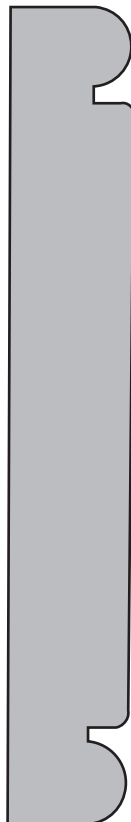

CRB425  
3/4 X 4 1/4 in.



CM398  
1/2 X 5 1/4 in.



CM956  
(WM956)  
7/16 X 4 1/4 in.



CRB525  
3/4 X 5 1/2 in.



CM6  
7/16 X 4 1/2 in.

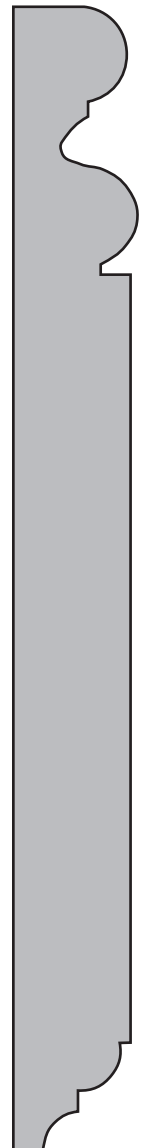

426  
5/8 X 6 in.

# PANEL MOULDING



Many more profiles available, call...1-800-861-0734 • FAX 1-800-861-0737

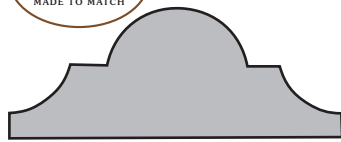

WM133  
3/4 X 1 3/4 in.

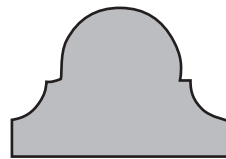

PM118  
3/4 X 1 in.

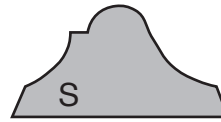

CM183 (WM183)  
9/16 X 1 1/8 in.



A9  
9/16 X 1 1/4 in.

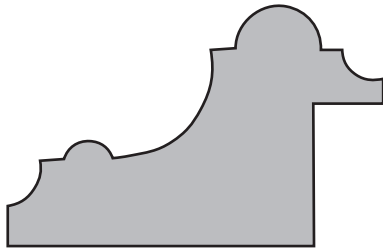

SM64  
1 1/4 X 2 in.

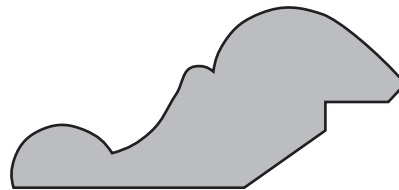

PM43  
1 5/16 X 2 1/8 in.

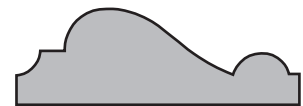

CM184 (WM184)  
1/2 X 1 1/2 in.

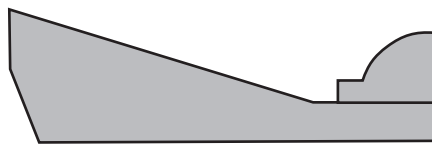

57      70  
1 1/16 X 2 1/4 in.      3/8 X 1 1/2 in.

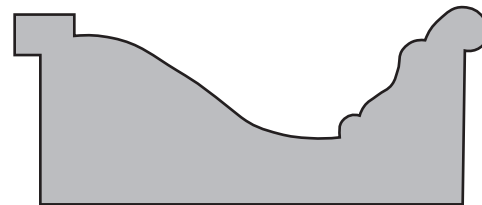

SM3514  
1 5/16 X 2 3/8 in.

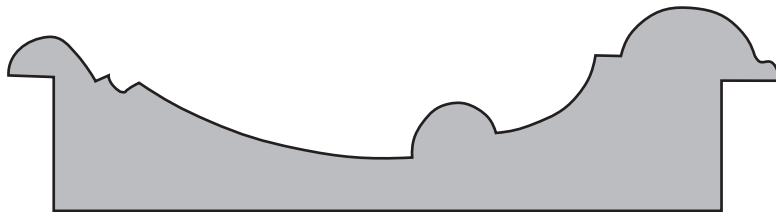

PM5126  
1 1/16 X 4 1/16 in.

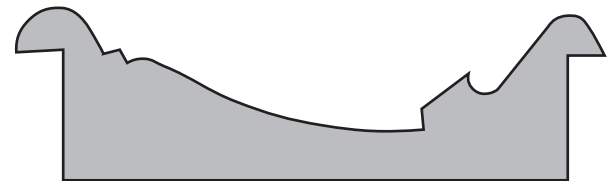

PM5127  
7/8 X 3 1/16 in.

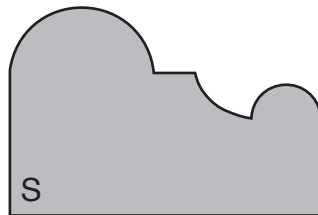

C42  
1 1/16 X 1 5/8 in.  
RABBETED  
Also Available:  
C42R 1/2  
C42R 3/4

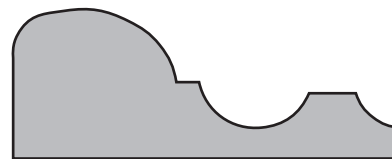

PM250  
3/4 X 2 in.  
RABBETED  
Also Available:  
PM250R4  
1/2 in.RAB  
PM250R5  
3/4 in.RAB

# BRICK MOULDING



1-800-861-0734 • FAX 1-800-861-0737



CM175 (WM175)  
1<sup>1</sup>/<sub>16</sub> X 2 in.



EC181  
1<sup>1</sup>/<sub>4</sub> X 3<sup>1</sup>/<sub>4</sub> in.

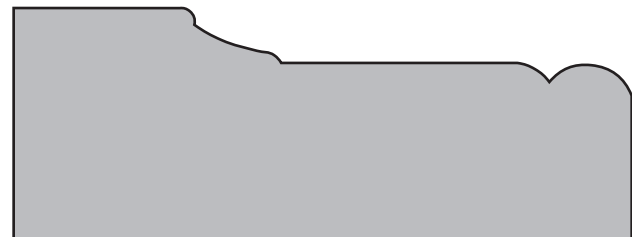

WM179  
1<sup>1</sup>/<sub>4</sub> X 3<sup>1</sup>/<sub>4</sub> in.

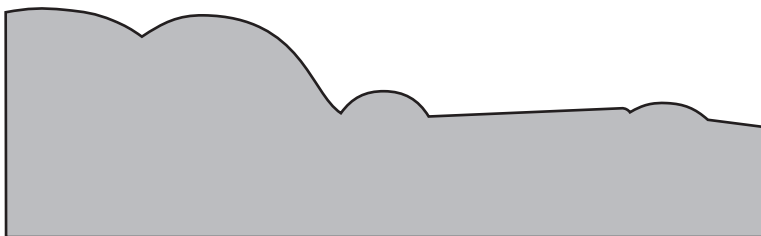

CONGRESSIONAL BMC (EC185)  
1<sup>1</sup>/<sub>4</sub> X 4 in.



CM180 (WM180)  
1<sup>1</sup>/<sub>4</sub> X 2 in.

# RAKES



Many more profiles available, call...1-800-861-0734 • FAX 1-800-861-0737

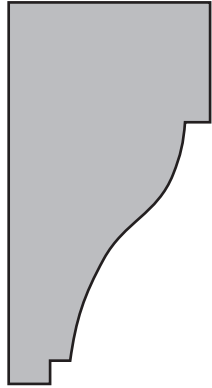

CM287 (WM287)  
1<sup>1</sup>/<sub>16</sub> X 2in.

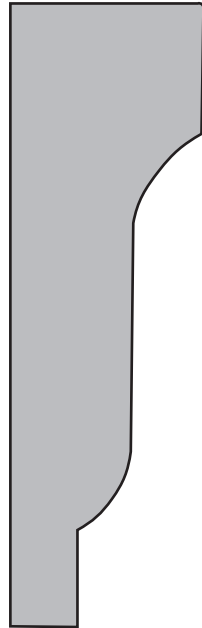

CM1206  
1 X 3<sup>1</sup>/<sub>16</sub>in.



CM212 (WM212)  
5/8 X 2<sup>1</sup>/<sub>2</sub>in.

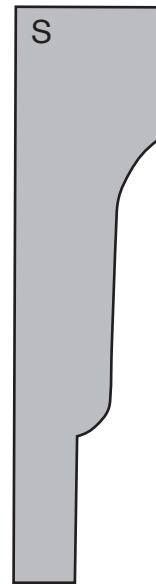

CM28  
3/4 X 3in.



CM207 (WM207)  
1<sup>1</sup>/<sub>16</sub> X 2<sup>1</sup>/<sub>2</sub> in.

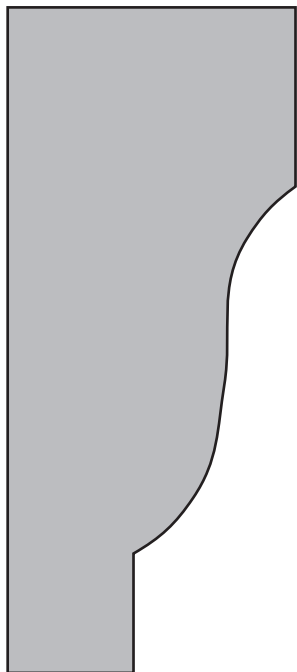

CM29  
1<sup>1</sup>/<sub>2</sub> X 3<sup>1</sup>/<sub>2</sub> in.

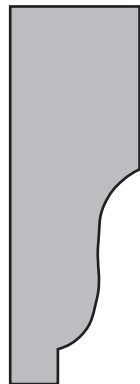

CM209 (WM209)  
1<sup>1</sup>/<sub>16</sub> X 2in.

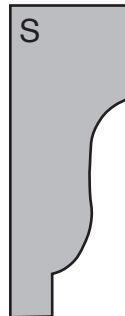

CM210 (WM210)  
5/8 X 1<sup>5</sup>/<sub>8</sub> in.

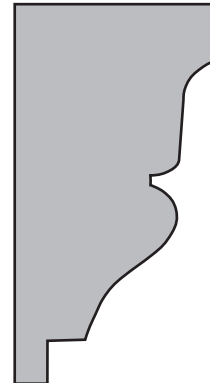

SM41 (WM286)  
1<sup>1</sup>/<sub>16</sub> X 2in.

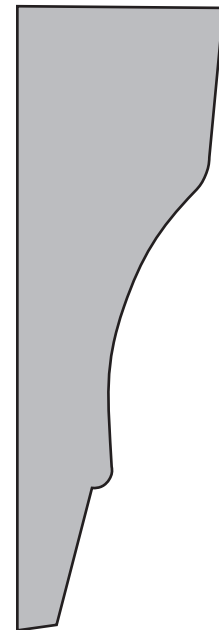

WP207  
1<sup>1</sup>/<sub>8</sub> X 3<sup>1</sup>/<sub>4</sub>in.



LWP286  
1<sup>1</sup>/<sub>16</sub> X 2in.

# VARIATIONS



1-800-861-0734 • FAX 1-800-861-0737

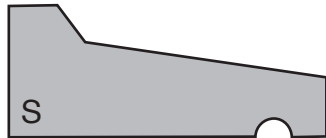

CM197  
1<sup>11</sup>/<sub>16</sub> X 1<sup>5</sup>/<sub>8</sub> in.

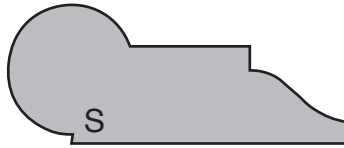

CM273 (WM273)  
1<sup>11</sup>/<sub>16</sub> X 1<sup>3</sup>/<sub>4</sub> in.



CM988  
3/8 X 1<sup>1</sup>/<sub>2</sub> in.  
Also Available:  
CM987  
3/8 X 2 in.



CM137  
9/16 X 1<sup>1</sup>/<sub>4</sub> in.



HR150  
1<sup>1</sup>/<sub>2</sub> X 3/4 in.



HR100  
1 X 1/2 in.



CM131  
(Ogee Shoe)  
7/16 X 3/4 in.

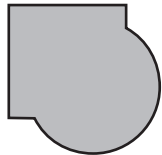

PENCIL MOULD  
5/8 X 5/8 in.

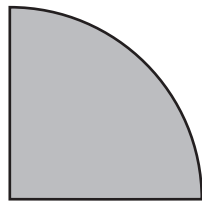

1in. QR.  
1in. X 1in.

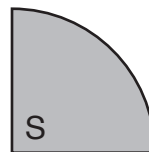

CM105 (WM105)  
3/4 X 3/4 in.

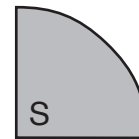

CM106 (WM106)  
1<sup>11</sup>/<sub>16</sub> X 1<sup>11</sup>/<sub>16</sub> in.

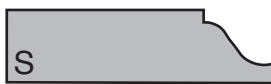

CM936  
3/8 X 1<sup>3</sup>/<sub>8</sub> in.  
Also Available:  
CM937  
3/8 X 1<sup>1</sup>/<sub>4</sub> in.



CM940  
7/16 X 7/8 in.  
Also Available:  
CM941A  
7/16 X 5/8 in.  
CM941  
7/16 X 3/4 in.



CM127  
7/16 X 1<sup>1</sup>/<sub>16</sub> in.



CM126 (WM126)  
1/2 X 3/4 in.

# VARIATIONS



Many more profiles available, call...1-800-861-0734 • FAX 1-800-861-0737

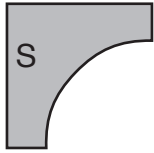

CM93  
3/4 X 3/4 in.

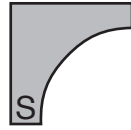

CM100  
1<sup>1</sup>/<sub>16</sub> X 1<sup>1</sup>/<sub>16</sub> in.



CM101  
1/2 X 1/2 in.



SCOTIA  
WM1075  
1/2 X 3/4 in.

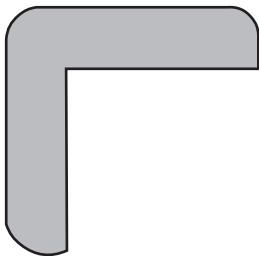

CM204 (WM204)  
1<sup>5</sup>/<sub>16</sub> X 1<sup>5</sup>/<sub>16</sub> in.

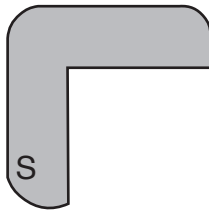

CM205  
1<sup>1</sup>/<sub>16</sub> X 1<sup>1</sup>/<sub>16</sub> in.

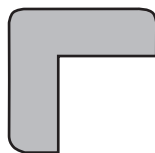

CM206  
3/4 X 3/4 in.

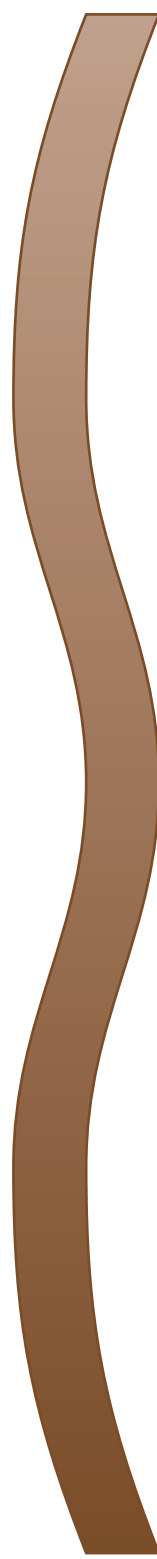

| FLEX JAMB  |  |
|------------|--|
| 496        | 3/4 X 4 <sup>9</sup> / <sub>16</sub> in. |
| 696        | 3/4 X 6 <sup>9</sup> / <sub>16</sub> in. |
| EASED EDGE |  |

| S4S       |  |
|-----------|--|
| 1 X 2     | 3/4 X 1 <sup>1</sup> / <sub>2</sub> in.  |
| 1 X 2 NET | 3/4 X 2 in.                              |
| CMXJ      | 3/4 X 3 <sup>1</sup> / <sub>16</sub> in. |
| 1 x 4     | 3/4 X 3 <sup>1</sup> / <sub>2</sub> in.  |
| 1 x 6     | 3/4 X 5 <sup>1</sup> / <sub>2</sub> in.  |
| 1 x 8     | 3/4 X 7 <sup>1</sup> / <sub>2</sub> in.  |
| 1 x 10    | 3/4 X 9 <sup>1</sup> / <sub>4</sub> in.  |
| 1 x 12    | 3/4 X 11 <sup>1</sup> / <sub>4</sub> in. |
| 5/4 x 4   | 1 X 3 <sup>1</sup> / <sub>2</sub> in.    |
| 5/4 x 6   | 1 X 5 <sup>1</sup> / <sub>2</sub> in.    |
| 5/4 x 8   | 1 X 7 <sup>1</sup> / <sub>2</sub> in.    |
| 5/4 x 10  | 1 X 9 <sup>1</sup> / <sub>4</sub> in.    |
| 5/4 x 12  | 1 X 11 <sup>1</sup> / <sub>4</sub> in.   |

# INDEX



## PAGE 5- CASINGS

CM356  
CM366  
CM445  
CM444  
CM376  
CM444A  
CM470  
CM442  
CM1  
CM97

## PAGE 6

CCC525  
C606R  
SM75  
SM85  
C606F  
SM5806

## PAGE 7

C600R  
CM14R  
CM14F  
PT338F  
PT338R  
1002  
1002M  
CNF312  
CCC350  
SM8

## PAGE 8

SM12  
CM445A  
CFC 214  
CFC 315 (NS)  
CFC 425 (NS)  
24112 PCA  
2814  
CM460  
CM371  
MD2  
NH234

## PAGE 9

SM7  
CM327  
CRK350  
PM719  
WM351  
CBG275  
RIDOUT376  
CAS50  
CKN425

## PAGE 10

LSM2060  
BM1188  
CN400  
CBG400  
CRC350  
CRC425

## PAGE 11

CGA425  
COXCOMB  
NH358  
WM371

CKN350  
CM361  
SM83

## PAGE 12

SM80  
CJF425  
LWM 97

C425  
MISS JENNY  
CAG425

## PAGE 13

CM433  
CM473  
CAS30  
CM452  
SM2050  
BM995  
SM 5701

## PAGE 14

CAM350  
BM1455  
C352  
RBI SPR3  
BM255  
CAM400  
SM84

## PAGE 15

RBI208  
CTE350  
CM683  
TM1  
399  
MS1661  
SM2051  
CW1

## PAGE 16

C351  
WM444  
LDFCA4  
CKM234  
SM82  
EC490

## PAGE 17

CBG300  
SM47  
PT312  
SM2  
CM466  
PRESIDENTIAL

## PAGE 18

P LARGE HOWE  
TMMH  
DELTA HOWE  
CKN535  
CM10  
CVA350  
CVA525  
MS11

## PAGE 19-BACK BANDS

C282  
CM809  
4048USBB  
97BB  
SM68  
CM142  
4048  
C281  
3436BB  
SM2513

## PAGE 20

SM2501-2  
SM2501  
CM280  
BB200  
SM2510  
SM2511-2  
SM2511  
CM289  
CRC150  
GP281  
CM281

## PAGE 21- CROWN

SM27  
SM603  
BM6  
SM29  
SM42

## PAGE 22

AH40  
CM48  
WM80  
CM541  
COLONIAL COVE

## PAGE 23

SM81  
SM86 (NS)  
RBCCM625  
TP41  
CM449C  
CM6449C (NS)

## PAGE 24

SM1136  
BBS725  
CCM725  
CCM525 (NS)  
CCM425 (NS)  
BBS111

## PAGE 25

SM 21  
EC36  
SM38  
CM725L  
CM525L

## PAGE 26

SM32  
CM375L  
RB4  
BM51245  
RB7

## PAGE 27

AH61  
CRN39  
CM70(COX)  
CM53

## PAGE 28

MTV629  
COVE  
TLC500  
RBCCM525

## PAGE 29

CBM1554  
24168-US-CR  
9 DENTIL  
SM712

## PAGE 30

CM549  
CM37  
SMITH DENTIL CRN  
SM1157

## PAGE 31

CM45 (1-1/8" Cove)  
CM52  
CM47  
SM1160  
CM49

## PAGE 32

AH41  
MS43  
USL42  
CM70

## PAGE 33

MCM 20-5  
COX48  
CM17  
CM74  
CM75  
CM49L

(NS)=Not shown but available





# INDEX



Many more profiles available, call...1-800-861-0734 • FAX 1-800-861-0737

## PAGE 34-CROWN BACKERS

SM4008  
CRB250  
AH19  
CM2  
WINDSOR  
1701  
BR CROWN ENHANCER

## PAGE 35-BASES

CM810  
CM618  
CM710  
BCB500  
BCB300 (NS)  
BCB400 (NS)  
BCB700 (NS)  
BCB925 (NS)

MS5180  
CM663

## PAGE 36

612  
SM97  
CM610  
CM623  
CM218  
CM753  
CM750 (NS)  
CM750W (NS)

## PAGE 37

CM616  
TWPB  
MDF714  
BBJ725  
BBJ525  
BBJ325 (NS)  
BBJ425 (NS)

## PAGE 38

BLB525  
BLB425 (NS)  
BLB725 (NS)  
VICTORIAN BASE  
MBC38-5  
LDFBA718  
AH617

## PAGE 39 BASE CAPS

CM166  
CM164  
CM163  
CM167  
1201  
SM30  
W39  
SM64  
MS287  
SM54  
SM43  
LWP 114  
BCB 150  
SM40

## PAGE 40 CHAIR RAIL

C136  
CM390  
4  
CR560  
CM302  
CR290  
CRAL333  
HH133

## PAGE 41

SM225  
MD4  
CM300  
GP200  
CM297  
CRA350  
CM397

## PAGE 42 CHAIR RAIL BACKER

CM957  
CRB425  
CM956  
CM6  
CM425(C135)  
CM398  
CRB525  
426

## PAGE 43 PANEL MOULDING

MPM20  
PM118  
CM183  
A9  
SM64  
PM43  
CM184  
57,70  
SM3514  
PM5127  
PM5126  
C42  
C42R1/2(NS)  
C42R3/4 (NS)  
PM250  
PM250R4(NS)  
PM250R5(NS)

## PAGE 44 BRICK MOULDING

AH181  
CM175  
WM179  
CONGRESSIONAL BMC  
CM180

## PAGE 45 RAKES

CM287  
CM1206  
CM212  
CM28  
CM207  
CM29  
CM209  
CM210

## PAGE 45 CONTINUED

SM41(WM286)  
LWP286  
WP207

## PAGE 46 VARIATIONS

CM273  
CM197  
CM137  
CM988  
CM987 (NS)  
HR150  
HR100  
CM131  
PENCIL MOULD

1IN. QR.  
CM105  
CM106  
CM936  
CM937 (NS)  
CM940  
CM941A (NS)  
CM941 (NS)

## PAGE 47

CM127  
CM126  
CM93  
CM100  
WM1075  
CM101  
CM204  
CM205  
CM206  
S4S- 13 Sizes

FLEX JAM 496 &696

We have many more profiles available that may suit your specific design requirements. We are always available to recreate your custom patterns at...

1-800-861-0734



4264 Old Linwood Road  
Linwood, NC 27299

1-800-861-0734

FAX 1-800-861-0737

US MAIL AT:

PO BOX 189  
Linwood, NC 27299







**FLEX TRIM™**



**by CARTER MILLWORK**

4264 Old Linwood Road  
Linwood, NC 27299  
1-800-861-0734  
FAX 1-800-861-0737  
[www.flextrim.com](http://www.flextrim.com)